



AC30 series Variable Speed Drive

HA503711U001 Issue 4: Hardware Installation Manual Frames D - J

aerospace
climate control
electromechanical
filtration
fluid & gas handling
hydraulics
pneumatics
process control
sealing & shielding



ENGINEERING YOUR SUCCESS.

**FAILURE OR IMPROPER SELECTION OR IMPROPER USE OF THE PRODUCTS DESCRIBED HEREIN OR RELATED ITEMS
CAN CAUSE DEATH, PERSONAL INJURY AND PROPERTY DAMAGE.**

This document and other information from Parker Hannifin Corporation, its subsidiaries and authorized distributors provide product or system options for further investigation by users having technical expertise.

The user, through its own analysis and testing, is solely responsible for making the final selection of the system and components and assuring that all performance, endurance, maintenance, safety and warning requirements of the application are met. The user must analyze all aspects of the application, follow applicable industry standards, and follow the information concerning the product in the current product catalogue and in any other materials provided from Parker Hannifin Corporation or its subsidiaries or authorized distributors.

To the extent that Parker Hannifin Corporation or its subsidiaries or authorized distributors provide component or system options based upon data or specifications provided by the user, the user is responsible for determining that such data and specifications are suitable and sufficient for all applications and reasonably foreseeable uses of the components or systems.

The above disclaimer is being specifically brought to the user's attention and is in addition to and not in substitution to the Exclusions and Limitations on Liability which are set out in the terms and conditions of sale.

AC30 Series Hardware Installation Manual

Frames D - J

HA503711U001 Issue 4



2019 © Parker Hannifin Manufacturing Limited.

All rights strictly reserved. No part of this document may be stored in a retrieval system, or transmitted in any form or by any means to persons not employed by a Parker Hannifin Manufacturing Limited company without written permission from Parker Hannifin Manufacturing Ltd. Although every effort has been taken to ensure the accuracy of this document it may be necessary, without notice, to make amendments or correct omissions Parker Hannifin Manufacturing Limited cannot accept responsibility for damage, injury, or expenses resulting therefrom.

WARRANTY

The general terms and conditions of sale of goods and/or services of Parker Hannifin Europe Sàrl, Luxembourg, Switzerland Branch, Etoy, apply to this contract unless otherwise agreed. The terms and conditions are available on our website: www.parker.com/termsandconditons/switzerland

Parker Hannifin Manufacturing Limited reserved the right to change the content and product specification without notice.

Contents Page No.

Chapter 1: Safety 1-1

Requirements.....	1-1
Intended Users	1-1
Application Area.....	1-1
Personnel.....	1-2
Hazards	1-2

Chapter 2: Introduction 2-1

About this Manual	2-1
Packaging and Lifting Details	2-3

Chapter 3: Product Overview..... 3-1

Product Range	3-1
Power Stack Features	3-2
Functional Overview	3-3
AC30 Series Control Features.....	3-5

Chapter 4: Installation - Power Stack..... 4-1

Cubicle Mount Power Stack	4-1
Dimensions for Cubicle Mount Installation.....	4-1
Through Panel Mount Power Stack.....	4-2
Dimensions for Through Panel Installation	4-2
Additional Mounting Brackets for Through Panel Installation (Frames F-J Only)	4-3
Mounting The Power Stack In A Cubicle.....	4-4
Mounting the Inverter.....	4-4
Ventilation.....	4-4
Cubicle Mounting Details	4-5
Cubicle Mounting Details: Vibration Mounts For Marine Applications (Frames D-H ONLY).....	4-6
Through Panel Mounting Detail	4-7

Contents Page No.

Electrical Installation.....	4-8
Wiring Instructions	4-8
Terminal Cover Removal.....	4-9
AC fed power Wiring Connections	4-10
DC FED Power Wiring Connections	4-11
Dynamic Brake Resistor Wiring Connections.....	4-13
Power Stack Terminal Block Wire Range	4-14
Power Stack Terminal Tightening Torques	4-18
Cabling Brackets & C2 Filter Solution Output Ringcores	4-19
Retaining The IP20 Rating Of The Top Terminal Cover (Frames H & J ONLY)	4-20
power Stack – Y-cap & VDR Disconnects.....	4-21

Chapter 5: Installation - Control Module 5-1

Control Module	5-1
Product Dimensions	5-1
Control Module Electrical Installation	5-2
Wiring Instructions	5-2
Control Module Cover Removal.....	5-3
Control Module Removal.....	5-4
AC30V Control Wiring Connections.....	5-5
AC30P, AC30D & AC30A - Control Wiring Connections.....	5-6
System Board Control Wiring Connections (AC30D Only)	5-7
System Board Control Wiring Connections (AC30A Only)	5-8
System Board Encoder Wiring Diagram (AC30A Only)	5-9
Wiring Diagrams	5-10
The Default Application.....	5-10
Application Description.....	5-10
Application 0: Basic Speed Control	5-12
Application 1: Auto/Manual Control	5-14
Application 2: Raise / Lower Trim	5-16
Application 3: Presets Speeds	5-18
Application 4: PID Control	5-20
Application 5: Active Front-End	5-22
Control Module Terminal Block Wire Range	5-24
Control Module Terminal Block Cable & Ferrule Recommendations..	5-24
Control Module Cabling Bracket (Optional)	5-25
Ethernet Communications Cable.....	5-26

2 Contents

<i>Contents</i>	<i>Page No.</i>
Ethernet Cable Recommendation	5-27
Option & Communication Card Installation Details (Optional)	5-28
SD Card Installation	5-30
Fitting a Remote GKP.....	5-31
Chapter 6: Associated Equipment - Power Stack	6-1
AC Line Fed 710 Stacks: Connection Overview	6-1
AC Line Input Fuses	6-2
Circuit Breakers (alternative to AC Line Fuses).....	6-3
External EMC Filters (optional)	6-4
AC Line Chokes (optional).....	6-5
Dynamic Braking Resistors (optional)	6-6
AC Motor Chokes (optional)	6-8
DC Link Fed 740 Stacks: Connection Overview	6-9
AC Line Input Fuses	6-10
External EMC Filters (optional)	6-10
AC Line Choke	6-10
Pre-charge Considerations.....	6-11
Dynamic Braking Resistors (optional)	6-11
DC Link Input Fuses	6-12
AC Motor Chokes	6-12
AFE System: Connection Overview	6-13
AC Line Input Fuses	6-14
External EMC Filters (optional)	6-14
DC Link Input Fuses	6-14
AC Motor Chokes	6-14
Line Synchronisation Card & AC30 Control Module	6-15
Additional Accessories.....	6-16
Gasket Kits	6-16

<i>Contents</i>	<i>Page No.</i>
Cabling Brackets	6-17
Vibration Mounts (For Marine Applications).....	6-17
Chapter 7: Associated Equipment - Control Module	7-1
Cabling Brackets	7-1
Option Cards	7-1
Communication Cards	7-2
SD Memory Cards.....	7-2
Graphical Keypad (GKP).....	7-3
Chapter 8: Safe Torque Off SIL3/PLe	8-1
General Information	8-1
STO Functional Description.....	8-2
Alignment to European Standards	8-3
EN ISO13849-1:2008	8-3
EN61800-5-2:2007 and EN61508	8-4
Safety Specification	8-5
EMC Specification	8-6
User Connections	8-7
STO Technical Specification	8-9
Inputs Specification	8-9
Output Specification.....	8-9
Truth Table	8-10
STO Input Timing Diagrams	8-11
Ideal Operation.....	8-11
Typical Operation.....	8-12
Fault Operation	8-13
Pulsed Inputs	8-14
STO State Transition Diagram.....	8-15
STO Trip Annunciation	8-16
Safety Warnings and Limitations	8-17

<i>Contents</i>	<i>Page No.</i>
Example User Wiring	8-19
Applications that do not require STO function.....	8-19
Minimum STO Implementation.....	8-20
STO Implementation with Safety Control Unit.....	8-21
SS1 Implementation using Safety Control Unit.....	8-23
STO Function Checking.....	8-25
Comprehensive Check.....	8-26
The following test steps must be performed:.....	8-27
Regular Check.....	8-29
Troubleshooting	8-30
Chapter 9: The Graphical Keypad	9-1
Overview.....	9-1
Keypad.....	9-2
LED Status Indication	9-3
The Display.....	9-4
Top Line - Inverter Status Summary.....	9-4
Bottom Line – Soft Key Action Indication.....	9-5
The Menu System	9-6
Navigating the Menu System	9-6
Read-only Parameter Indication	9-6
Changing a Parameter Value.....	9-6
Setup Wizard	9-7
Firmware Update	9-8
Chapter 10: Routine Maintenance & Repair	10-1
Routine Maintenance	10-1
Preventative Maintenance	10-1
Main Duct Fans.....	10-1
DC Link Capacitors	10-3
Repair.....	10-3
Saving Your Application Data	10-3

<i>Contents</i>	<i>Page No.</i>
Returning the Unit to Parker	10-3
Appendix A: Compliance.....	A-1
Applicable Standards	A-1
EUROPEAN COMPLIANCE	A-2
CE Marking	A-2
EMC Compliance.....	A-4
EMC Standards	A-5
Radiated Emissions Standards	A-5
Conducted Emissions Standards.....	A-6
Radiated Emissions - Compliance Overview	A-7
Conducted Emissions - Compliance Overview	A-8
EMC Installation Guidance	A-12
Protective Earth (PE) Connections.....	A-12
Mitigating Radiated Emissions	A-14
Cabling Requirements.....	A-16
Harmonic Information – AC Supplied Inverters	A-20
Requirements for North American and Canadian Compliance A-26	
North American Compliance.....	A-26
Canadian Compliance	A-27
North American and Canadian Compliance Information.....	A-27
Maritime Rules & Standards Compliance	A-29
Det Norske Veritas (DNV GL) Compliance (Frames D-H Only).....	A-29
Environmental.....	A-30
Restriction, Evaluation, Authorisation and Restriction of Chemicals (REACH)	A-30
Restriction of Hazardous Substances (RoHS)	A-30
Waste Electrical and Electronic Equipment (WEEE)	A-31
Appendix B: E Plan Library.....	B-1
E Plan Library.....	B-1

4 Contents

Contents Page No.

Appendix D: AC30 Series Product CodesD-1

Understanding the Product Code	D-1
AC30 Series Control Module	D-1
AC30 Series Power Stack	D-2
Configured AC30 Series Inverter	D-3
AC30 Series Regenerative Supply Unit.....	D-4

Appendix E: Technical Specifications - Power Stack...E-1

Environmental Details.....	E-1
Safety Details.....	E-2
Earthing Details.....	E-2
Cooling Fans	E-3
AC FED Electrical Ratings.....	E-4
DC FED Electrical Ratings.....	E-7
AFE Mode Electrical Ratings.....	E-10
Internal Dynamic Brake Switch.....	E-11

Appendix F: Technical Specifications - Control ModuleF-1

Environmental Details.....	F-1
Safety Details.....	F-2
Analog Inputs/Outputs.....	F-2
Reference Outputs	F-3
Digital Inputs	F-3
Digital Outputs	F-3
User 24V Supply Output	F-4
Auxiliary 24V Input (AC30V & AC30P Only).....	F-4
Relay Outputs (AC30V Only).....	F-4
System Auxiliary 24V Input (AC30D & AC30A Only).....	F-5
System Board Digital Inputs (AC30D & AC30A Only)	F-5
System Board Digital Outputs (AC30A Only)	F-6
Pulse Encoder Power Supply Output (AC30D Only).....	F-6
Sin/Cos Encoder Power Supply Output (AC30A Only)	F-6
Pulse Encoder Inputs (AC30D Only).....	F-7
Sin/Cos Encoder Inputs (AC30A Only).....	F-8
RS485 ENDAT Encoder Inputs (AC30A Only).....	F-8
Encoder Transmit Outputs (AC30D & AC30A Only).....	F-9

Contents Page No.

Chapter 1: Safety

Safety Information

IMPORTANT Please read these important Safety notes before installing and operating this equipment

CAUTION

CAUTION notes in the manual warn of danger to equipment.

WARNING

NOTES IN THE MANUAL WARN OF DANGER TO PERSONEL

Requirements

Intended Users

This manual is to be made available to all persons who are required to install, configure or service equipment described herein, or any other associated operation.

The information given is intended to highlight safety issues, and to enable the user to obtain maximum benefit from the equipment. Complete the following table for future reference detailing how the unit is to be installed and used.

INSTALLATION DETAILS			
Model Number <i>(see product label)</i>		Where installed <i>(for your own information)</i>	
Unit used as a: <i>(refer to Certification)</i>	<input type="checkbox"/> Component <input type="checkbox"/> Relevant Apparatus	Unit fitted:	<input type="checkbox"/> Cubicle mounted <input type="checkbox"/> Through Panel Mounted

Application Area

The equipment described is intended for industrial motor speed control utilising AC induction motors or AC permanent magnet synchronous machines.

1-2 Safety

Personnel

Installation, operation and maintenance of the equipment should be carried out by competent personnel. A competent person is someone who is technically qualified and familiar with all safety information and established safety practices; with the installation process, operation and maintenance of this equipment; and with all the hazards involved.



DANGER
Risk of electric shock



WARNING
Hot surfaces



Caution
Refer to documentation



Earth/Ground
Protective Conductor Terminal

Hazards

DANGER! - Ignoring the following may result in injury

1. This equipment can endanger life by exposure to rotating machinery and high voltages.
2. The equipment must be permanently earthed due to the high earth leakage current, and the inverter motor must be connected to an appropriate safety earth.
3. Ensure all incoming supplies are isolated before working on the equipment. Be aware that there may be more than one supply connection to the inverter.
4. There may still be dangerous voltages present at power terminals (motor output, supply input phases, DC bus and the brake, where fitted) when the motor is at standstill or is stopped.
5. For measurements use only a meter to IEC 61010 (CAT III or higher). Always begin using the highest range. CAT I and CAT II meters must not be used on this product.
6. Allow at least 5 minutes for the inverter's capacitors to discharge to safe voltage levels (<50V). Use the specified meter capable of measuring up to 1000V dc & ac rms to confirm that less than 50V is present between all power terminals and between power terminals and earth.
7. Unless otherwise stated, this product must NOT be dismantled. In the event of a fault the inverter must be returned. Refer to "Routine Maintenance and Repair".

WARNING! - Ignoring the following may result in injury or damage to equipment

SAFETY

Where there is conflict between EMC and Safety requirements, personnel safety shall always take precedence.

- Never perform high voltage resistance checks on the wiring without first disconnecting the inverter from the circuit being tested.
- Whilst ensuring ventilation is sufficient, provide guarding and /or additional safety systems to prevent injury or damage to equipment.
- When replacing an inverter in an application and before returning to use, it is essential that all user defined parameters for the product's operation are correctly installed.
- All control and signal terminals are SELV, i.e. protected by double insulation. Ensure all external wiring is rated for the highest system voltage.
- Thermal sensors contained within the motor must have at least basic insulation.
- All exposed metalwork in the Inverter is protected by basic insulation and bonded to a safety earth.
- RCDs are not recommended for use with this product but, where their use is mandatory, only Type B RCDs should be used.

EMC

- In a domestic environment this product may cause radio interference in which case supplementary mitigation measures may be required.
- This equipment contains electrostatic discharge (ESD) sensitive parts. Observe static control precautions when handling, installing and servicing this product.
- This is a product of the restricted sales distribution class according to IEC 61800-3. It is designated as "professional equipment" as defined in EN61000-3-2 for frames sizes D & E (7.5kW). Permission of the supply authority shall be obtained before connection to the public low voltage supply. Frame sizes E (11kW) to N harmonics conform to the limits of IEC61000-3-12:2011 (table 4).

WARNING! – Control Unit Removal / Fitting

Isolate supply before plugging or unplugging control unit to the power stack.

CAUTION!

APPLICATION RISK

- The specifications, processes and circuitry described herein are for guidance only and may need to be adapted to the user's specific application. We can not guarantee the suitability of the equipment described in this Manual for individual applications.

RISK ASSESSMENT

Under fault conditions, power loss or unintended operating conditions, the inverter may not operate as intended. In particular:

- Stored energy might not discharge to safe levels as quickly as suggested, and can still be present even though the inverter appears to be switched off
- The motor's direction of rotation might not be controlled
- The motor speed might not be controlled
- The motor might be energised

An inverter is a component within an inverter system that may influence its operation or effects under a fault condition. Consideration must be given to:

- Stored energy
- Supply disconnects
- Sequencing logic
- Unintended operation

Chapter 2: Introduction

About this Manual

Who is this Manual aimed at?

This Manual is intended for use by the installer of the AC30 series inverters. It assumes a reasonable level of understanding in this discipline. It is more detailed than the relevant QuickStart manual.

There is a separate software reference - HA503711U003 'AC30 Series Software Reference Manual' that is intended for use by the user and programmer of the AC30 series inverters.

Note: It is important to always pass on this Manual to any new user of the AC30 series inverter.

How the Manual is Organised?

This Hardware Installation Manual is organised into chapters, indicated by the numbering on the edge of each page. If the manual is to be printed it is designed so that it should be printed double-sided using the short-edge for binding.

Information for the following AC30 units is included - Frame D, E, F, G, H & J power stacks, and AC30V, AC30P, AC30D & AC30A control modules which, are collectively referred to as "the Inverter" or "drive" throughout the manual.

Product coding: Any "x" within a product code indicates there are variants, see the 'Appendix D: AC30 Series Product Codes' section for more information.

AC30P
AC30D
AC30A

Any text placed in a highlighted area as this sample shows, only refers to the AC30P, AC30D and AC30A control modules.

Parker Hannifin Manufacturing Limited is referred to as "Parker" throughout the manual.



IMPORTANT

Please read all Safety information before proceeding with the installation and operation of this unit.



2-2 Introduction

Initial Steps

Use the manual to help you plan the following:

Installation

Know your requirements:

- certification requirements, CE/UL/CUL conformance - refer to the 'Appendix A: Compliance' section.
- conformance with local installation requirements.
- supply and cabling requirements - refer to 'Chapter 4: Installation – Power Stack' and 'Chapter 5: Installation – Control Module' sections.

Considerations

It is important to consider that:

- motors used must be suitable for Inverter duty.
- no attempt is made to control motors whose rated current is less than 25% of the inverter rated current. Poor motor control or Autotune problems may occur if you do.

Equipment Inspection

At the point of receipt of your new unit:

- Check for signs of transit damage.
- Check the product code on the rating label conforms to your requirement.

Equipment Storage

If the unit is not being installed immediately, store the unit in a well-ventilated place away from high temperatures, humidity, dust, or metal particles.

Storage and Shipping Temperatures	
Storage Temperature	-25°C to +55°C
Shipping Temperature	-25°C to +70°C

Packaging and Lifting Details



CAUTION



The packaging is combustible. Igniting it may lead to the generation of lethal toxic fumes.

Once in possession of the unit:

- Save the packaging in case of return. Improper packaging can result in transit damage.
- Use a safe and suitable lifting procedure when moving the unit. Never lift the unit by its terminal connections.
- Prepare a clear, flat surface to receive the inverter before attempting to move it. Do not damage any terminal connections when putting the unit down.
- Refer to 'Chapter 4: Installation – Power Stack' for further details on handling the products.

2-4 Introduction

Chapter 3: Product Overview

Product Range

Power Stacks – Frame Sizes D, E, F, G, H & J

Control Modules – AC30V, AC30P, AC30D & AC30A

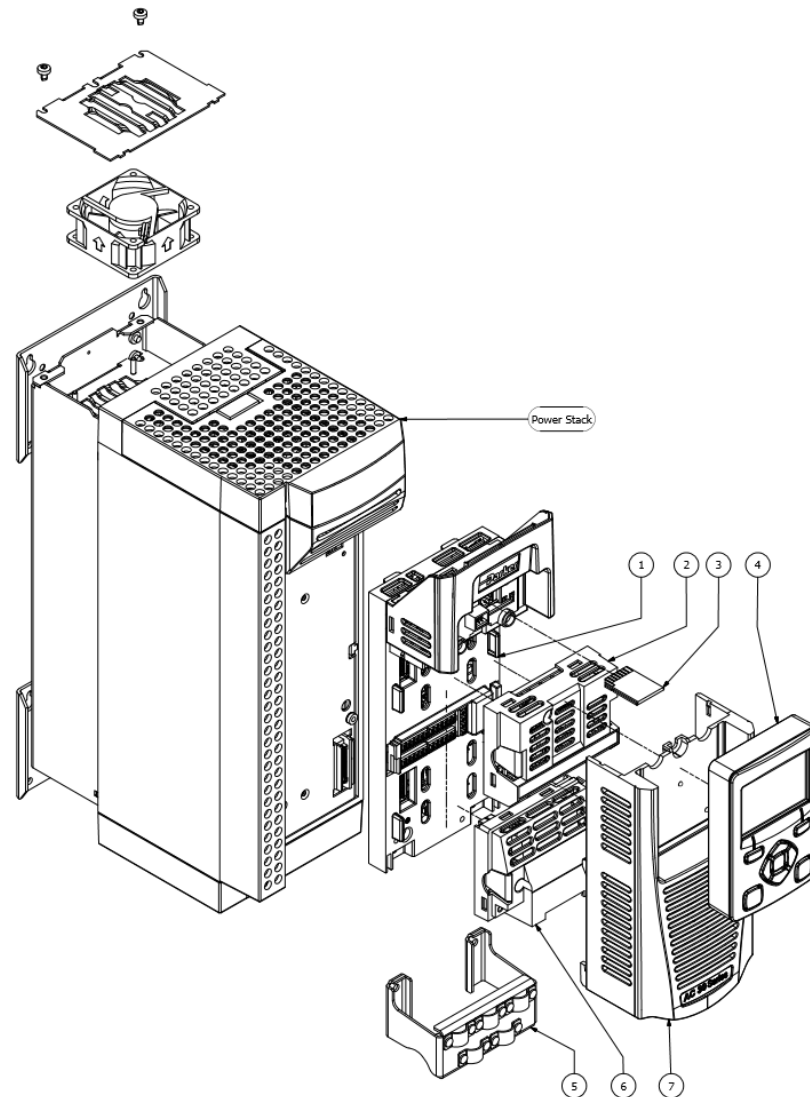

Control Module assembly including:

1. AC30 Control Module
2. Option Card
3. SD Memory Card
4. Graphical Keypad (GKP)
5. Cabling Bracket
6. Comms Card
7. Cover

See 'Chapter 7: Associated Equipment – Control Module' for details on accessories and option cards.

3-2 Product Overview

Power Stack Features

General	Switching Frequency	Minimum 2kHz Default 2.5kHz (Frames H & J), 3kHz (Frame G), 4kHz (Frames D, E & F) Maximum 12kHz (Frames D, E, F & G), 9kHz (Frame H), 8kHz (Frame J) Derating of output current will apply above the default switching frequency.
	Output Frequency	Maximum is Switching Frequency divided by 8. This is limited to 590Hz due to export rules. e.g. for 4kHz switching frequency it is $4000/8 = 500\text{Hz}$ Maximum is Switching Frequency divided by 6, in PMAC Motor Closed Loop Control. If >590Hz is required, please contact your local Parker Sales representative.
	Dual Rating	Normal duty (ND) Heavy duty (HD)
Stack Protection	Trip Conditions	Output scct: line-to-line & line-to-earth Overcurrent: 220% HD current / Stall Overvoltage & undervoltage Heatsink over-temperature Internal over-temperature (Frame J only) Missing output current sensor (Frame J only) Motor Thermistor over-temperature (using GPIO option) Dynamic Brake scct protection
	Current Limit	Adjustable 110% (ND) or 150% (HD) for 60s 180% shock load limit (Heavy Duty) Inverse Time
	Overload Rating	ND - 110% overload for 60s HD - 180% overload for 3s, 150% overload for 60s
User Terminals	Line Input	3 AC input terminals L1, L2, L3 (710 stacks only)
	Motor Output	3 AC output terminals - M1, M2, M3 (to be used as line supply connections for AFE applications)
	PE	2 protective earth terminals
	DC Input	2 DC input terminals DC+ and DC-
	Brake Output	2 DC output terminals DB+ and DB to be used when connecting a Dynamic Brake Resistor

Functional Overview

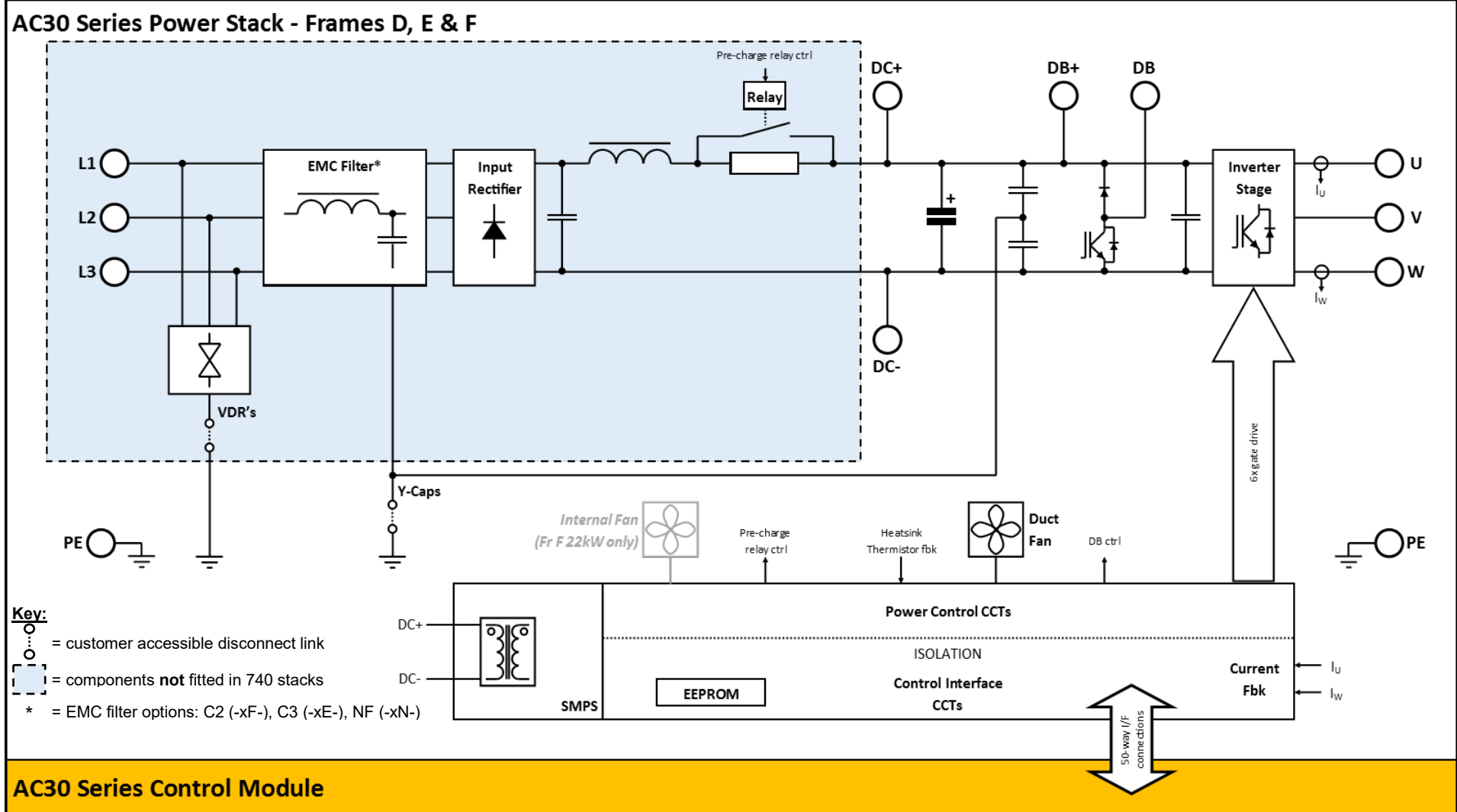

Block Diagram for Frames D, E, F

3-4 Product Overview

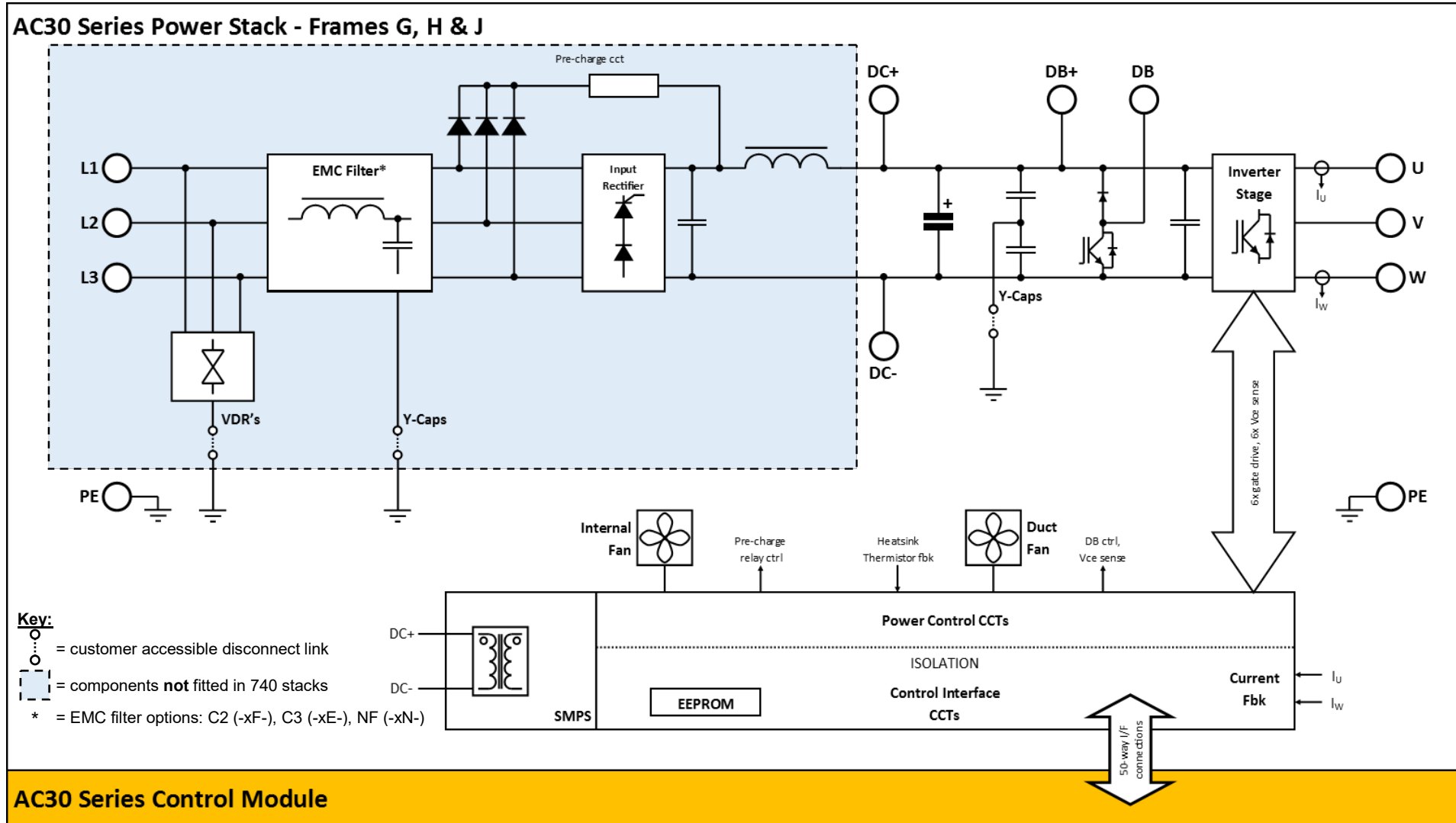

AC30 Series Control Features

The inverter is fully featured when controlled using the optional Keypad (or a suitable pc programming tool).

General	Motor Control Modes	Induction motor: <ul style="list-style-type: none"> - V/F control - Sensorless Vector Control - Closed Loop Vector Control (with encoder option) - Closed Loop Vector Control (with resolver option) PMAC motor: <ul style="list-style-type: none"> - Sensorless Vector Control - Closed Loop Vector Control (with encoder option) - Closed Loop Vector Control (with resolver option), though with power constraints 	
	AFE Mode	4Q Regen Control (with encoder option)	
	Voltage Boost for V/F control	0-25%	
	Skip Frequencies	Skip frequencies with adjustable skip band width	
	Preset Speeds	User selectable preset speeds	
	Stopping Modes	Ramp, Coast, DC Injection, Quickstop	
	S Ramp and Linear Ramp	Symmetric or asymmetric ramp up and down rates	
	Raise/Lower	Programmable MOP function	
	Jog	Programmable jog speed	
	Diagnostics	Full diagnostic and monitoring facilities	
	Inputs/ Outputs	Analog Inputs	2 configurable inputs: 1 voltage or current, 1 voltage only
		Analog Outputs	2 configurable outputs: 1 unipolar voltage or current, 1 bipolar voltage only
		Digital Inputs	3 configurable 24V dc inputs
		System Board Digital Inputs	3 configurable 24V dc inputs (AC30D & AC30A only)
Digital I/O		4 configurable 24V dc current sourcing outputs/digital inputs	
System Board Digital I/O		3 configurable 24V dc current sourcing outputs/digital inputs (AC30A only)	
Relay Outputs		2 configurable relay outputs (AC30V only)	
Reference Voltages		+/-10V dc outputs, user +24V dc output	
Aux Supply		+24V dc input	
Encoder Inputs		2 separate encoder input channels: A, /A, B, /B, Z, /Z (AC30D only) 1 sin/cos encoder input channel: sin+, sin-, cos+, cos-, Z, /Z & 1 Endat 2.1 encoder input channel: Data+, Data-, Clock+, Clock- (AC30A only)	
Encoder Supply Outputs	1 selectable encoder output supply voltage (AC30D & AC30A only)		
Encoder Outputs	1 encoder transmit channel: A, /A, B, /B, Z, /Z (AC30D & AC30A only)		
Comms	On-board Ethernet	1 port (AC30V only)	
		2 ports	

3-6 Product Overview

Chapter 4: Installation - Power Stack

IMPORTANT Read 'Appendix A: Compliance' before installing this unit.

Cubicle Mount Power Stack

DIMENSIONS FOR CUBICLE MOUNT INSTALLATION

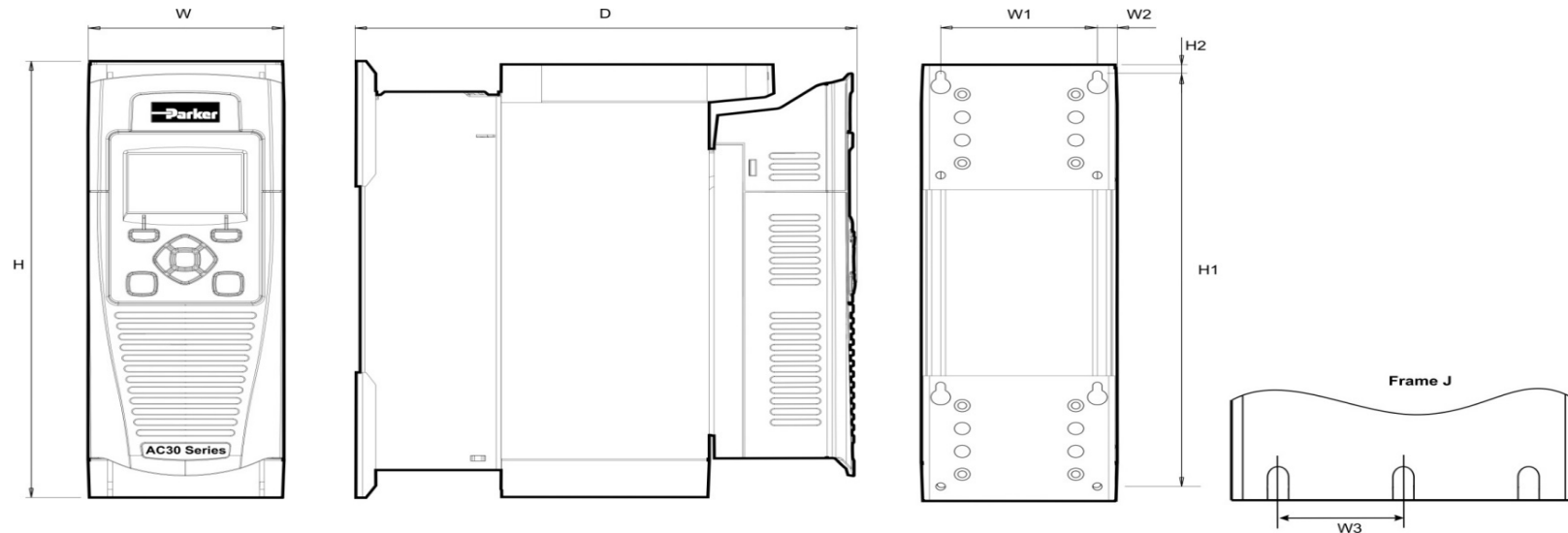

Frame Size	Max. Weight kg (lbs)	Product Dimensions										Fixing Details	
		H (AC30V/P)	H (AC30D)	H1	H2	W	W1	W2	W3	D (AC30V/P)	D (AC30D/A)	Slot	Fixing
D	4.5 (10)	286.0 (11.26)	298.0 (11.73)	270.0 (10.6)	6.5 (0.25)	100.0 (3.93)	80.0 (3.15)	10.0 (0.39)		255.0 (10.0)	273.0 (10.75)	4.5 (0.18)	M4
E	6.8 (15)	333.0 (13.11)	333.0 (13.11)	320.0 (12.6)	6.5 (0.25)	125.0 (4.92)	100.0 (3.93)	12.5 (0.49)		255.0 (10.0)	273.0 (10.75)	4.5 (0.18)	M4
F	10.0 (22)	383.0 (15.07)	383.0 (15.07)	370.0 (14.5)	6.5 (0.25)	150.0 (5.90)	125.0 (4.92)	12.5 (0.49)		255.0 (10.0)	273.0 (10.75)	4.5 (0.18)	M4
G	22.3 (49.2)	480.0 (18.90)	480.0 (18.90)	465.0 (18.31)	7.25 (0.29)	220.0 (8.66)	190.0 (7.48)	13.0 (0.51)		287.0 (11.30)	305.0 (12.01)	5.5 (0.22)	M5
H	45.5 (100.3)	670.0 (26.38)	670.0 (26.38)	650.0 (25.59)	10.0 (0.39)	260.0 (10.24)	220.0 (8.66)	20.0 (0.79)		316.0 (12.44)	334.0 (13.15)	6.8 (0.27)	M6
J	80.5 (177.5)	800.0 (31.50)	800.0 (31.50)	780.0 (30.71)	10.0 (0.39)	330.0 (12.99)	285.0 (11.22)	23.0 (0.91)	142.5 (5.61)	374.0 (14.72)	392.0 (15.43)	9.0 (0.35)	M8

All dimensions are in millimetres (inches)

4-2 Installation - Power Stack

Through Panel Mount Power Stack

DIMENSIONS FOR THROUGH PANEL INSTALLATION

Through panel mounting an inverter in a cubicle allows you to use a smaller cubicle because much of the heat generated by the inverter is dissipated outside the cubicle.

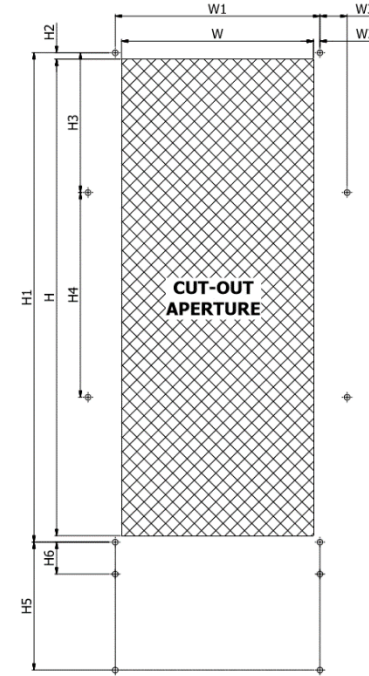
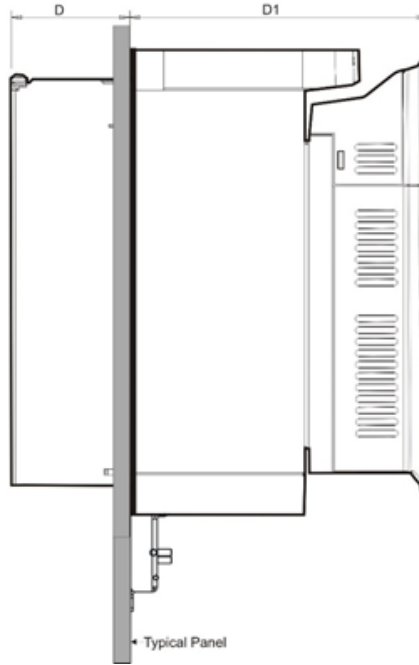
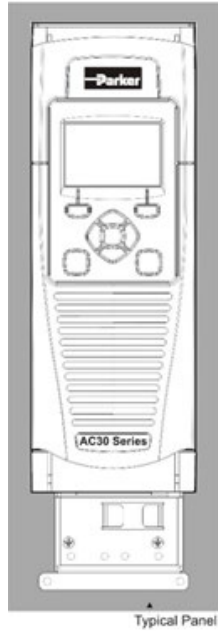

For product weight and outline details, see page 4-1.

Back panel cut-out & fixing hole dimensions

Frame Size	Cut-Out Aperture		Fixing Positions						Product Depths			Fixing Details				
	H	W	H1	H2	H3	H4	H5*	H6*	W1	W2†	W3	D	D1 (AC30V/P)	D1 (AC30D/A)	Slot	Fixings
D	250 (9.8)	82 (3.2)	262 (10.3)	6 (0.2)			64 (2.5)		79 (3.1)	-1.5 (-0.06)		72 (2.8)	181 (7.1)	199 (7.83)	6x4.5	M4
E	297 (11.7)	102 (4.0)	309 (12.1)	6 (0.2)			80 (3.1)		104 (4.1)	1.0 (0.04)		72 (2.8)	181 (7.1)	199 (7.83)	6x4.5	M4
F	347 (13.7)	127 (5.0)	359 (14.1)	6 (0.2)	147.5 (5.8)		90 (3.5)		129 (5.1)	1.0 (0.04)	20.5 (0.8)	72 (2.8)	181 (7.1)	199 (7.83)	6x4.5	M4
G	440 (17.3)	195 (7.7)	455.8 (17.9)	7.9 (0.3)	225.8 (8.9)		130 (5.1)		195.8 (7.7)	0.4 (0.015)	22 (0.9)	95 (3.7)	192 (7.6)	210 (8.27)	6x5.5	M5
H	617 (24.3)	227 (8.9)	641 (25.2)	12 (0.5)	207.5 (8.2)	220 (8.7)	210 (8.3)	38.5 (1.5)	218 (8.6)	-4.5 (-0.2)	37 (1.5)	99 (3.9)	211 (8.3)	229 (9.0)	8x6.5	M6
J	745 (29.3)	300 (11.8)	765 (30.1)	10 (0.4)	218.5 (8.6)	320 (12.6)			275 (10.82)	-12.5 (-0.5)	42.5 (1.7)	128 (5.0)	245.1 (9.7)	263.1 (10.4)	8x9	M8

* = dimension for cabling bracket fixings (if fitted),

† = when dimension is shown as a **negative** value, drive fixing position pitch width is less than cut out width

All dimensions are in millimetres (inches)

ADDITIONAL MOUNTING BRACKETS FOR THROUGH PANEL INSTALLATION (FRAMES F-J ONLY)

When through panel mounting a Frame Size F - J inverter, additional mounting brackets are required.

These are included with the gasket kits listed in 'Chapter 6: Associated Equipment'.

The back panel fixing positions for these brackets is given in the table on page 4-2.

Frames F & G

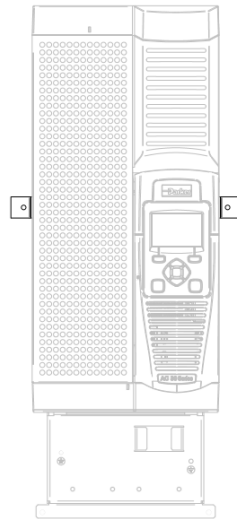

Frame H

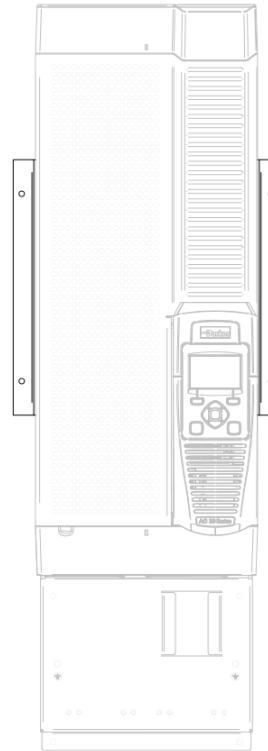

Frame J

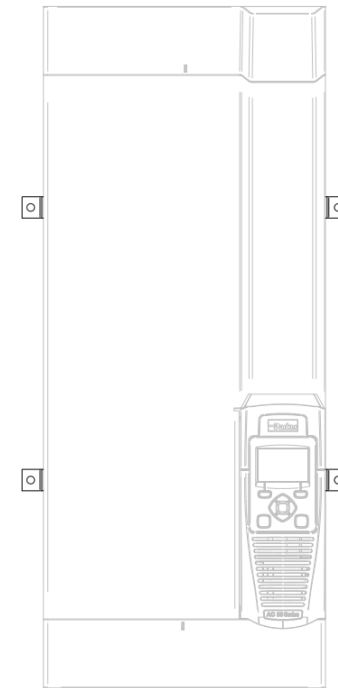

4-4 Installation - Power Stack

Mounting The Power Stack In A Cubicle

MOUNTING THE INVERTER

These units are not suitable for wall mounting. They must be mounted vertically inside an additional enclosure.

Refer to 'Appendix A: Compliance' for information on the EMC requirements of the inverter and cubicle installation.

Note: Frames sizes H & J are heavy and will require two people to lift or the use of a fork lift to install it. The products will stand vertically on flat surfaces.

VENTILATION

The inverter gives off heat in normal operation and must therefore be mounted to allow the free flow of air through the ventilation slots and heatsink. Maintain minimum clearances for ventilation as given in the tables below to ensure adequate cooling of the inverter, and that heat generated by other adjacent equipment is not transmitted to the inverter. Be aware that other equipment may have its own clearance requirements. When mounting two or more inverters together, these clearances are additive. Ensure that the mounting surface is normally cool. The inverter must be mounted in a suitable cubicle.

Minimum Air Clearance for Product/Application (Europe: IP2x, USA/Canada: Open Type):

Cubicle Mount

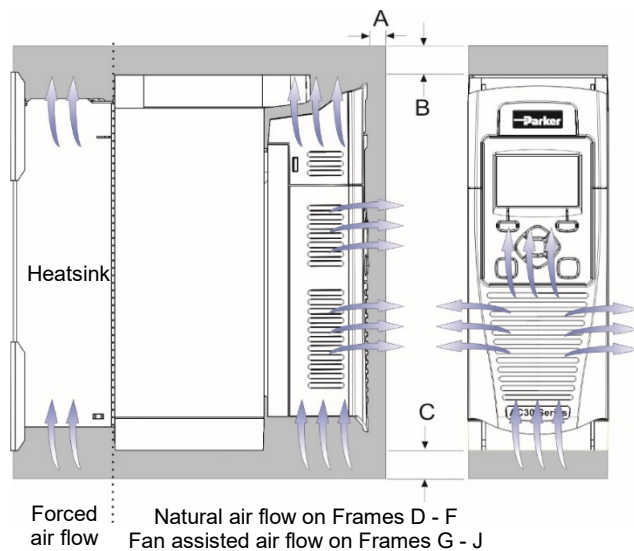

Frame Size	Product Clearances (mm)		
	A	B	C [†]
D	10	75	75
E			
F			
G			
H	10	100	100
J			
† = excludes cabling requirements			

Through-Panel Mount

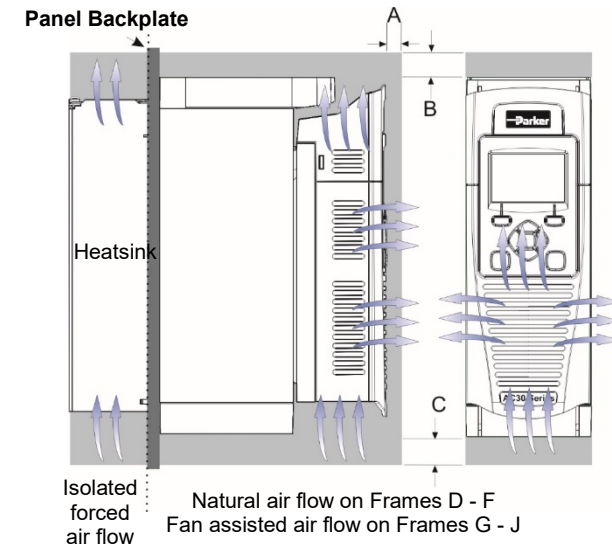

CUBICLE MOUNTING DETAILS

When installing a cubicle mounted inverter, the product is shipped with the mounting brackets already fitted ready for installation.

The Frames D – G have two mounting brackets that are both adjustable at 15mm intervals.

The Frames H & J have a single mounting bracket that spans the length of the product and is not adjustable.

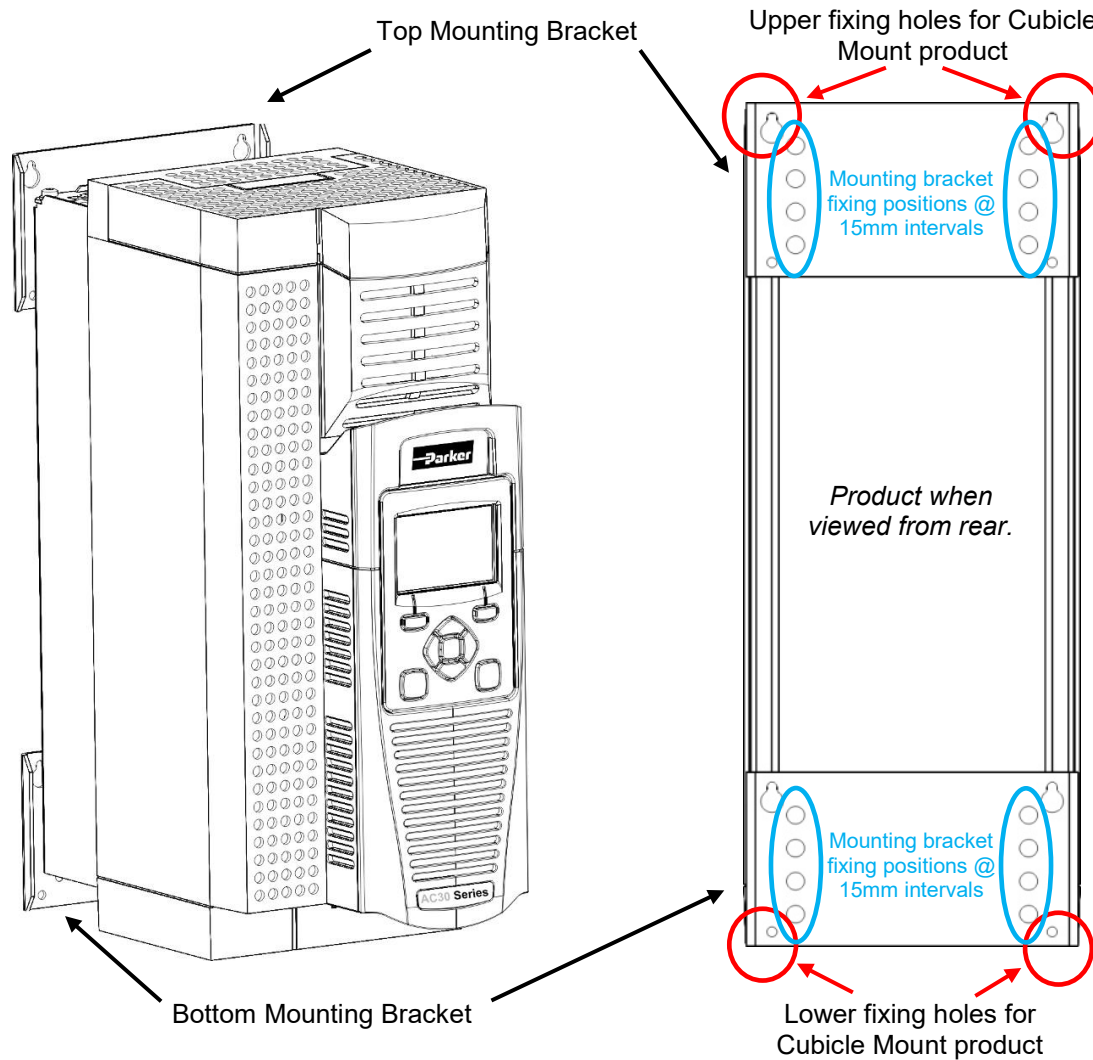

Steps 1 & 2 apply to Frames D – G only:

1. If required, remove the mounting bracket(s) by unscrewing the fixings.
2. Reposition the mounting bracket(s) to the desired position and secure with the fixings.
3. Fix the inverter to the cubicle back panel using the fixing holes provided by the mounting bracket(s).
4. The inverter is now ready for wiring.

4-6 Installation - Power Stack

CUBICLE MOUNTING DETAILS: VIBRATION MOUNTS FOR MARINE APPLICATIONS (FRAMES D-H ONLY)

Vibration mounting kits are available for compliance with Det Norske Veritas' (DNV GL) Rules for Classification of Ships, Offshore Units and High Speed & Light Craft. These are listed in the 'Chapter 6: Associated Equipment – Power Stack' section.

All vibration mounting kits consist of anti-vibration mounts, mount fixings, and an additional control module fixing screw required for DNV compliance. The Frame G kit also contains mounting brackets to replace the ones that are shipped with the product.

Anti-Vibration Mounts						
Frame Size	Anti-Vibration Mount			Fixing Nut		Torque Nm (lb-in)
	H*	ØD	Thread ØD x L	Nut		
D	15 (0.59)	15 (0.59)	M4	13 (0.51)	M4	1.8 (16)
E						
F						
G	20 (0.79)	25 (0.98)	M6	18 (0.71)	M6	5 (44)
H	20 (0.79)	25 (0.98)	M6	18 (0.71)	M6	5 (44)

* = additional product depth dimension
All dimensions are in millimetres (inches)

Steps 1 & 2 apply to the Frame G **only**:

1. Remove the mounting brackets by unscrewing the fixings.
2. Replace with the mounting brackets supplied in the kit and secure with the fixings.

Note: The fixing holes on the cubicle back panel will have to be increased from M5 to M6 when using these mounting brackets.

3. Fix the anti-vibration mounts to the cubicle back panel using the nuts provided. Torque to the recommended value.
4. Fix the inverter onto the anti-vibration mounts by the mounting bracket(s), using the nuts provided. Torque to the recommended value.
5. The inverter is now ready for wiring.
6. Once the power stack has been wired up, fit the additional M3x20 screw to the AC30 Control Module. Torque to 1Nm.

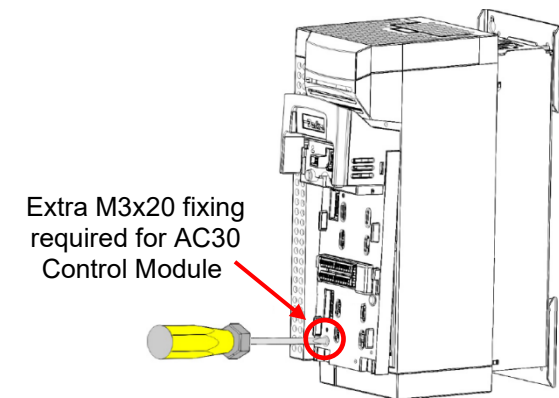
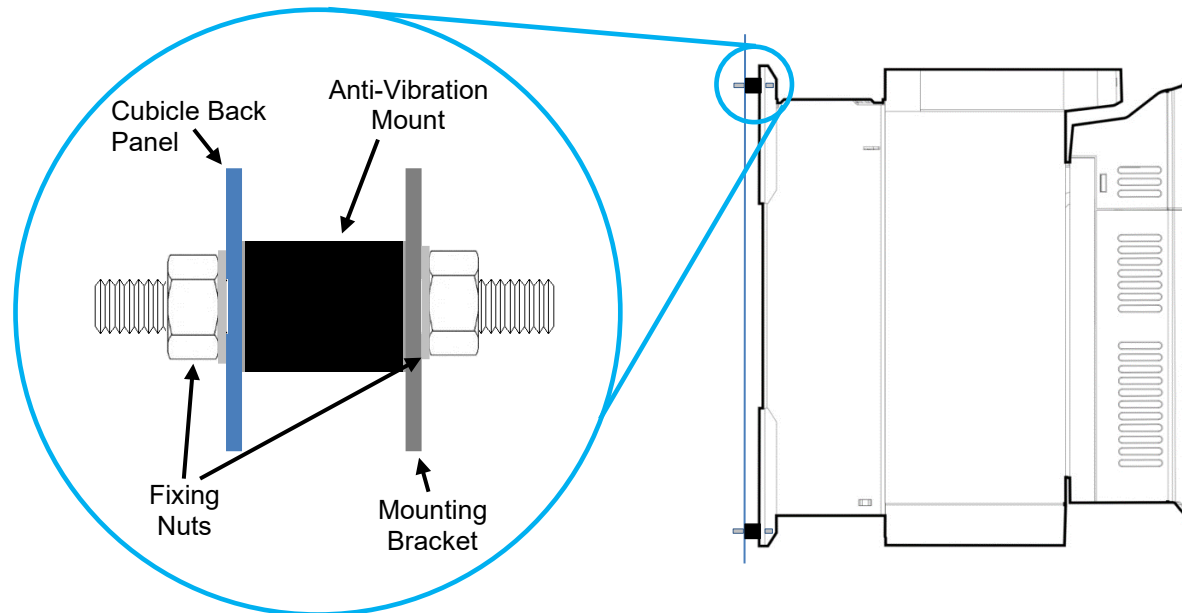

THROUGH PANEL MOUNTING DETAIL

When installing a through panel inverter, the mounting brackets must be removed and a gasket must be fitted between the inverter and the cubicle back panel:

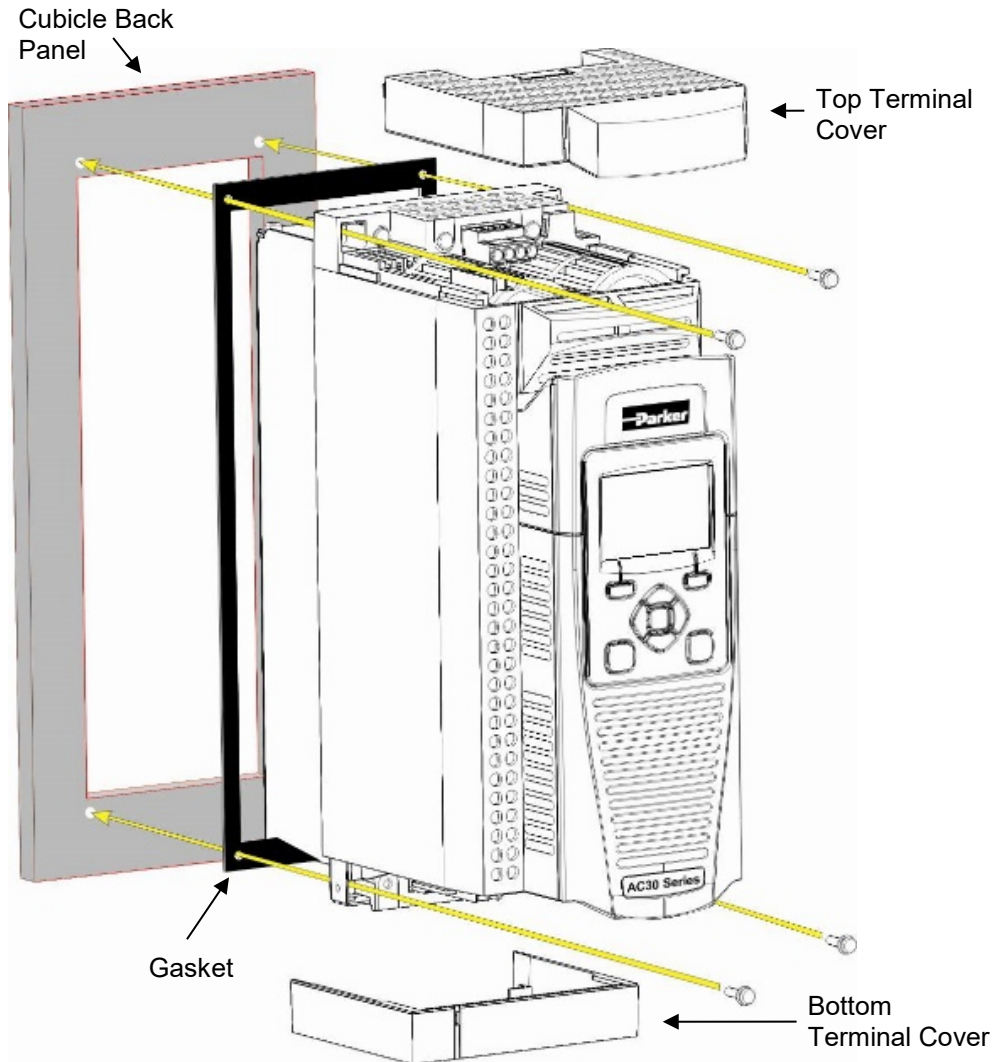

1. Remove the mounting bracket(s) by unscrewing the fixings.
2. Remove the top and bottom terminal covers (see page 4-9).
3. Attach the additional brackets included in the through panel kit, to the inverter (Frames F - J only).
4. Fit the through panel gasket between the cubicle back panel and the inverter, as the inverter is offered up to the panel. The gasket should provide an air-tight seal between the inverter and the back panel.
5. Tighten the four fixings in the corners of the product, in addition to any fixings required for the additional through panel brackets.
6. The inverter is now ready for wiring.

4-8 Installation - Power Stack

Electrical Installation

IMPORTANT Please read the Safety Information in “Chapter :1 Safety” before proceeding.

WIRING INSTRUCTIONS

Protective Earth (PE) Connections



The unit must be **permanently earthed**.

Refer to ‘Appendix A: Compliance’ for further information.

Supply Fuses / Circuit Breakers

Protect the incoming mains supply using suitable fuses or a circuit breaker (circuit breaker types RCD, ELCB, GFCI are not recommended).

Refer to ‘Chapter 6: Associated Equipment – Power Stack’ for recommended fuses, and other systems components that may be required for use with the inverter.



DANGER – RISK OF ELECTRIC SHOCK

Terminal covers, main covers, and cover fixings must remain in place while the drive is energised.

These should only be ever be removed once the supply to the unit has been disconnected, and the residual energy in the DC link capacitors has been discharged.



All activities covered in this chapter should be carried out when there is no power to the inverter.

If the drive has been powered up, ensure enough time has elapsed that the inverter has discharged it’s residual energy.

Always check that the voltages on the user terminals are at a safe level (<50V) before carrying out any of these activities.

STO always overrides any attempt to start the inverter. If one or both STO control inputs is requesting the STO function, the inverter will not start, even if for example, the inverter’s software malfunctions and tries to cause the motor to turn.

Refer to ‘Chapter 8: Safe Torque Off SIL3/PLe’ for further information.

TERMINAL COVER REMOVAL

The bottom terminal cover will need to be removed prior to connecting any AC line input cables to or motor output cables from the inverter:

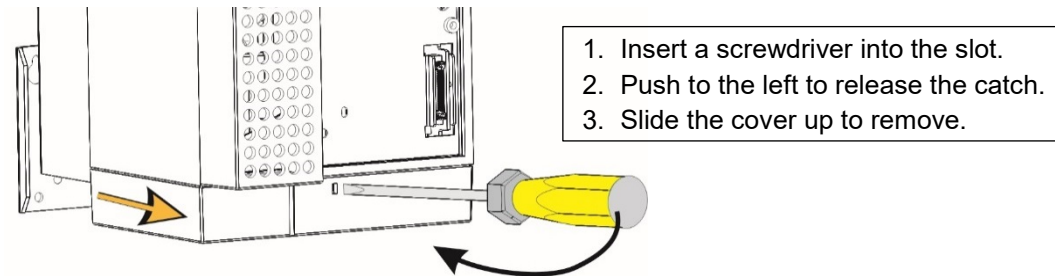

The top terminal cover will need to be removed in order to connect the DC link input cables or brake cables to the inverter:

Frame D

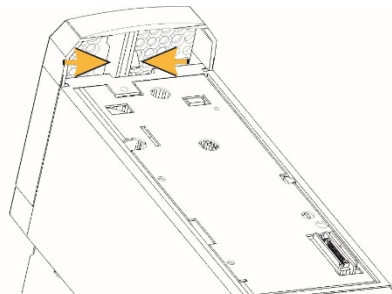

1. Remove the control module if fitted. Refer to 'Chapter 5: Installation – Control Module' for details.
2. Squeeze the bracket.
3. Slide the cover up to remove.

Frames E - J

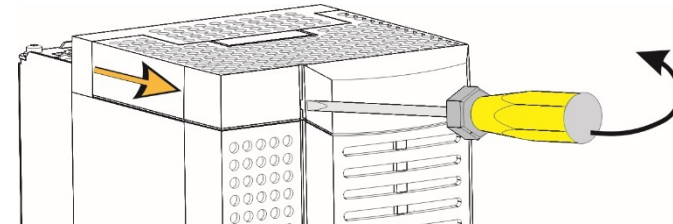

1. Insert a screwdriver into the slot.
2. Push to the right to release the catch.
3. Slide the cover up to remove.

4-10 Installation - Power Stack

AC FED POWER WIRING CONNECTIONS

Connect the incoming three phase supply cables into terminals L1, L2 & L3 respectively. Phase rotation is not critical.

Likewise, connect the three phase motor cables into terminals U, V & W. Phase rotation is important to ensure consistency between the inverter motor control direction and motor shaft rotation.

Connect both the incoming supply earth and motor earth to the inverter PE terminals.

710 Stack Bottom Terminals

Frames D – G

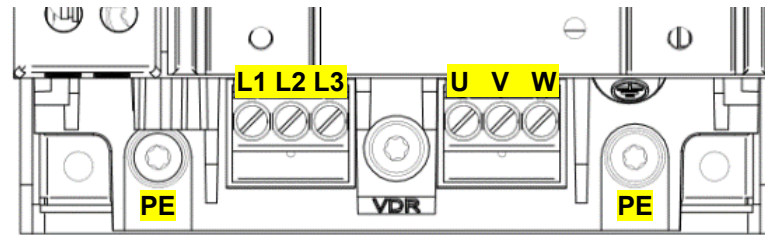

Frame H

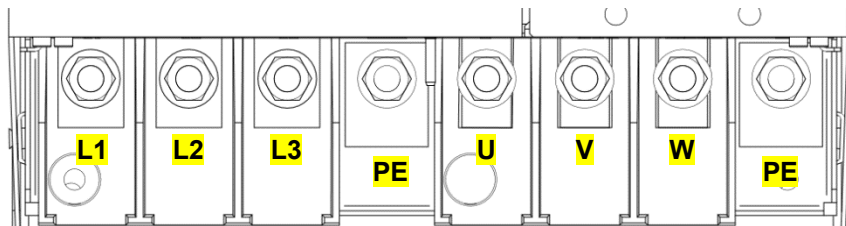

Frame J

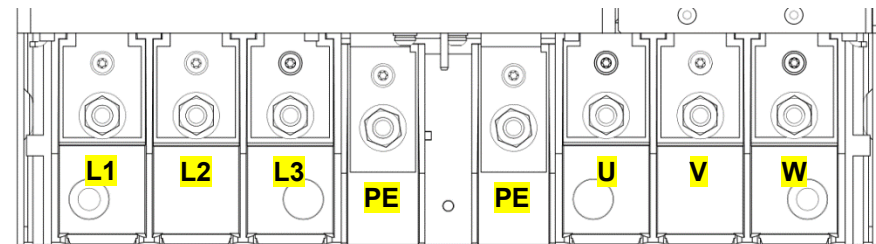

Refer to page 4-14 for terminal block wire ranges and page 4-18 for correct terminal torque guidelines.

Refer to 'Chapter 6: Associated Equipment – Power Stack' for recommended system components for use with the inverter.

DC FED POWER WIRING CONNECTIONS

Connect the DC supply cables into terminals DC+ & DC- respectively. It is important not to transpose these connections.

740 Stack Top Terminals

Frames D – G

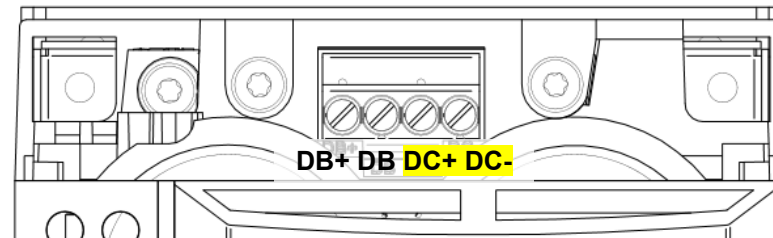

Frame H

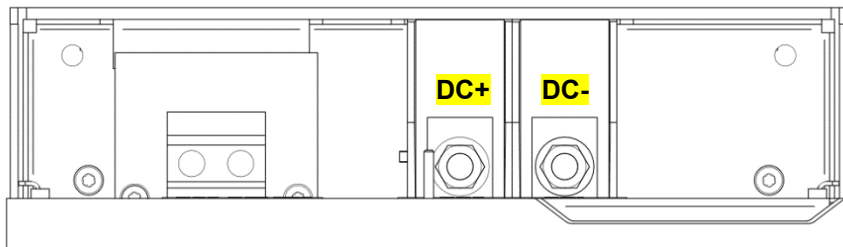

Frame J

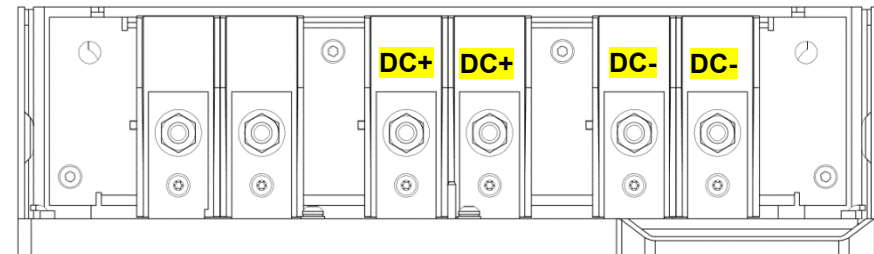

Refer to page 4-14 for terminal block wire ranges and page 4-18 for correct terminal torque guidelines.

Refer to page 4-20 for information on retaining the IP20 protection of the top terminal cover.

Refer to 'Chapter 6: Associated Equipment – Power Stack' for recommended system components for use with the inverter.

4-12 Installation - Power Stack

Connect the three phase motor cables into terminals U, V & W. Phase rotation is important to ensure consistency between the inverter control direction and motor shaft rotation.

When wiring an inverter for use as an AFE, terminals U, V & W are used to connect to the three phase mains supply.

Earth both the inverter and motor earth (or incoming supply for an AFE application) to the inverter PE terminals.

740 Stack Bottom Terminals

Frames D – G

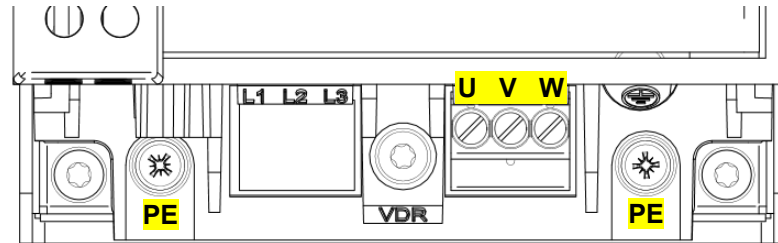

Frame H

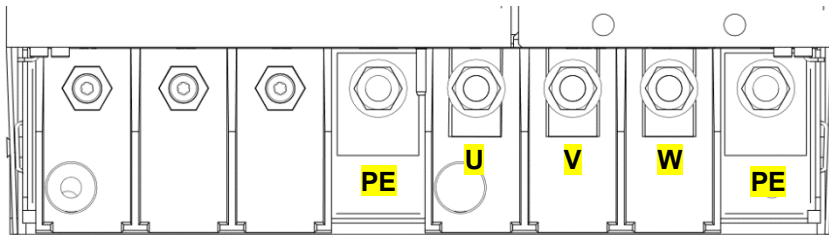

Frame J

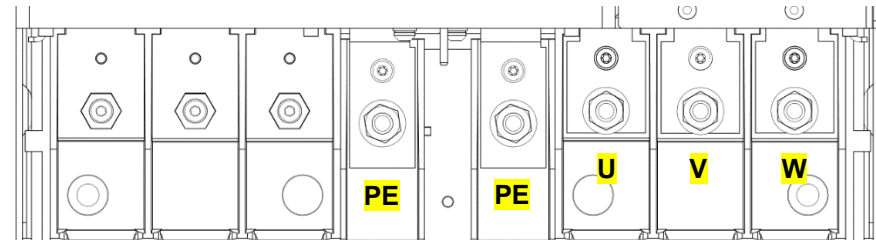

Refer to page 4-14 for terminal block wire ranges and page 4-18 for correct terminal torque guidelines.

Refer to Refer to 'Chapter 6: Associated Equipment – Power Stack' for recommended system components for use with the inverter.

DYNAMIC BRAKE RESISTOR WIRING CONNECTIONS

Where a Dynamic Brake Resistor (DBR) is required for an inverter application, connect across the terminals DB+ & DB.

740 Stack Top Terminals

Frames D – G

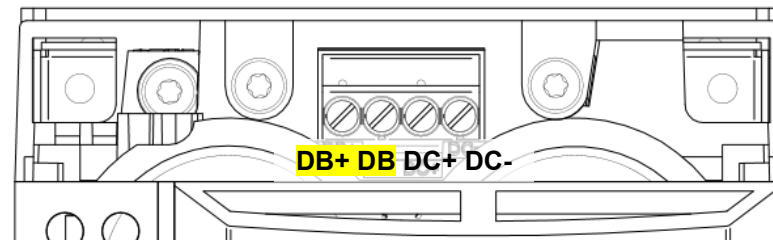

Frame H

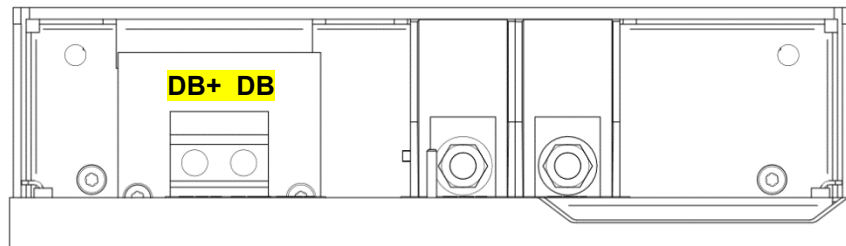

Frame J

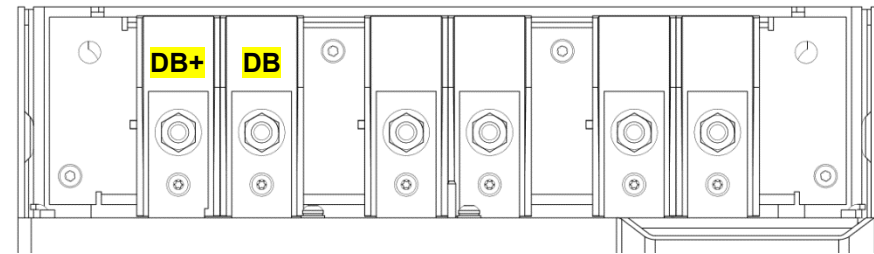

Refer to page 4-14 for terminal block wire ranges and page 4-18 for correct terminal torque guidelines.

Refer to page 4-20 for information on retaining the IP20 protection of the top terminal cover.

Refer to 'Chapter 6: Associated Equipment – Power Stack' for guidelines on how to calculate the size of the DBR for the users application.

4-14 Installation - Power Stack

POWER STACK TERMINAL BLOCK WIRE RANGE

Wire sizes for Europe should be chosen with respect to the inverter operating conditions, in addition to local National Electrical Safety Installation Requirements. Local wiring regulations always take precedence.

Frame Size	Power Terminals (minimum/maximum acceptance for aperture)			Earth Connections
	AC Line (L1, L2 L3) & Output (M1, M2, M3)	DC Link (DC+, DC-)	Brake (DB+, DB)	
D	0.05 - 6 mm ²			M4 ring crimp
E	0.05 - 6 mm ²			M4 ring crimp
F	1 - 10 mm ² (*16 mm ²)			M4 ring crimp
G	1.3 - 25 mm ²			M5 ring crimp
H	M8 post, accepting crimps or lugs up to width 26.5mm (minimum 25mm ² wire size)			M8 ring crimp
J	M8 post, accepting crimps or lugs up to width 32mm (minimum 25mm ² wire size)			M8 ring crimp Up to width 26.5mm
*The larger wire size can be used provided a crimp is fitted to the wire				

Installation - Power Stack 4-15

North American wire sizes (AWG) are based on NEC/NFPA-70 for ampacities of thermoplastic-insulated (75°C) copper conductors. The wire sizes allow for an ampacity of 125% of the rated input and output amperes for motor branch-circuit conductors as specified in NEC/NFPA-70.

Power Terminals Acceptance Range: 30–10 AWG					
Frame Size	Product Code	AC Line (L1, L2, L3)	DC Link (DC+, DC-)	Output (U, V, W)	Brake (DB)
D	Normal Duty				
	7x0-4D0004...	14	14	14	14
	7x0-4D0006...	14	14	14	14
	7x0-4D0010...	14	14	14	14
	7x0-4D0012...	14	14	14	14
	Heavy Duty				
	7x0-4D0004...	14	14	14	14
	7x0-4D0006...	14	14	14	14
	7x0-4D0010...	14	14	14	14
	7x0-4D0012...	14	14	14	14
E	Normal Duty				
	7x0-4E0016-...	12	12	12	14
	7x0-4E0023-...	10	10	10	14
	Heavy Duty				
	7x0-4E0016-...	14	14	14	14
	7x0-4E0023-...	12	14	12	14

All cables sizes are specified in AWG

4-16 Installation - Power Stack

Power Terminals Acceptance Range: 18–6 AWG					
Frame Size	Product Code	AC Line (L1, L2, L3)	DC Link (DC+, DC-)	Output (U, V, W)	Brake (DB)
F	Normal Duty				
	7x0-4F0032-...	8	8	8	12
	7x0-4F0038-...	8	8	8	10
	7x0-4F0045-...	6	6	6	8
	Heavy Duty				
	7x0-4F0032-...	10	10	10	12
	7x0-4F0038-...	8	8	8	10
7x0-4F0045-...	8	8	8	8	

All cables sizes are specified in AWG

Power Terminals Acceptance Range: 16–4 AWG					
Frame Size	Product Code	AC Line (L1, L2, L3)	DC Link (DC+, DC-)	Output (U, V, W)	Brake (DB)
G	Normal Duty				
	7x0-4G0045-...	6	6	6	8
	7x0-4G0060-...	4	4	4	6
	7x0-4G0073-...	3	3	3	4
	Heavy Duty				
	7x0-4G0045-...	8	8	8	8
	7x0-4G0060-...	6	6	6	6
7x0-4G0073-...	4	4	4	4	

All cables sizes are specified in AWG

Power Terminal - Busbars					
Frame Size	Product Code	AC Line (L1, L2, L3)	DC Link (DC+, DC-)	Output (U, V, W)	Brake (DB)
H	Normal Duty				
	7x0-4H0087-...	3	2	2	3
	7x0-4H0105-...	2	1	1/0	2
	7x0-4H0145-...	1/0	2/0	3/0	1/0
	Heavy Duty				
	7x0-4H0087-...	4	3	3	3
	7x0-4H0105-...	3	2	2	2
	7x0-4H0145-...	2	1/0	1/0	1/0
J	Normal Duty				
	7x0-4J0180-...	3/0	4/0	4/0	3/0
	7x0-4J0205-...	4/0	(300)	(250)	4/0
	7x0-4J0260-...	(350)	(500)	(350)	(300)
	Heavy Duty				
	7x0-4J0180-...	1/0	3/0	4/0	3/0
	7x0-4J0205-...	3/0	4/0	(300)	4/0
	7x0-4J0260-...	(250)	(300)	(400)	(300)

Cable sizes are specified in AWG or (kcmil)

4-18 Installation - Power Stack

POWER STACK TERMINAL TIGHTENING TORQUES

Frame Size	Power Terminals			Earth Studs
	AC Line (L1, L2 L3) & Output (M1, M2, M3)	DC Link (DC+, DC-)	Brake (DB)	
D	0.56 - 0.8 (5 - 7)	0.56 - 0.8 (5 - 7)	0.56 - 0.8 (5 - 7)	1.8 (16)
E	0.56 - 0.8 (5 - 7)	0.56 - 0.8 (5 - 7)	0.56 - 0.8 (5 - 7)	1.8 (16)
F	1.35 (12)	1.35 (12)	1.35 (12)	1.8 (16)
G	2.0 (18)	2.0 (18)	2.0 (18)	3.6 (32)
H	20 (177)	20 (177)	2.0 (18)	20 (177)
J	20 (177)	20 (177)	20 (177)	20 (177)

All torques are maximum values in Nm (lb-in)

CABLING BRACKETS & C2 FILTER SOLUTION OUTPUT RINGCORES

All AC line fed products (710 stacks) that are available with an internal C2 filter (710-4xxxxx-xF... product codes), include an external cabling bracket and output ringcore(s) as part of the filter solution.

To fit the Cabling Bracket:

1. Remove the bottom terminal cover as instructed on page 4-9.
2. Secure the Cabling Bracket to the power stack chassis tray using the fixings provided (see diagram below).

To fit the output Ringcore:

1. Position the output ringcore in the cutout on the cabling bracket.
2. Pass the three motor supply conductors through the centre of the ringcore when connecting to the inverter terminals U, V & W.

Note: The earth connection **does not** pass through the centre of the ringcore.

3. The cable clamps supplied with the cabling bracket should be used to clamp down on the exposed cable screen, providing a 360° screen termination point.

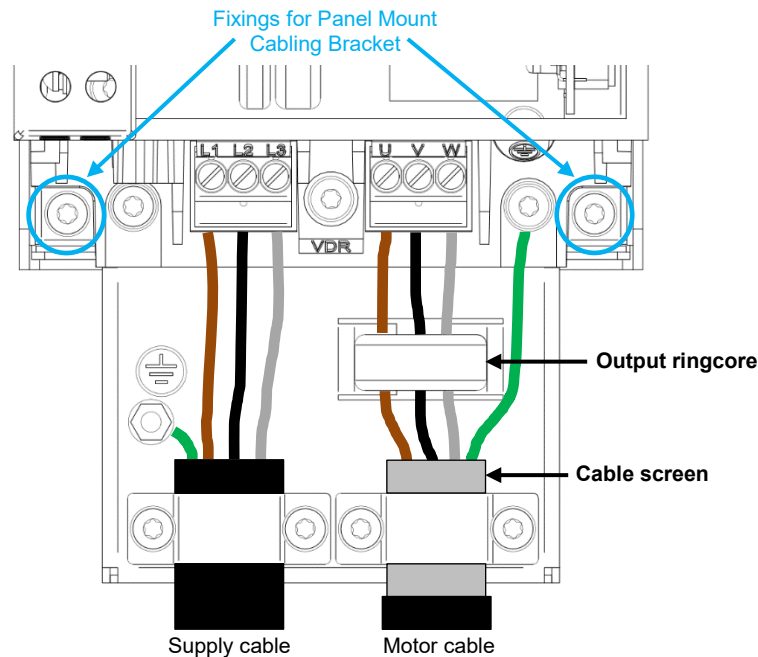

Notes:

1. Power stack cabling brackets are available for all products (Frames D-J). These are listed in the 'Chapter 6: Associated Equipment – Power Stack' section.
2. If a customer has a Frame D-F drive with an internal C3 filter (710-4xxxxx-xE...), the addition of the cabling bracket kit (that includes the output ringcore) will mean that the inverter becomes a C2 filtered product (710-4xxxxx-xF...). This is the case with these Frame sizes **only**. The Frame G-J cabling brackets do not include output ringcores, and the C3 filtered products cannot be converted to meet the lower C2 levels.

4-20 Installation - Power Stack

RETAINING THE IP20 RATING OF THE TOP TERMINAL COVER (FRAMES H & J ONLY)

In order to retain IP20 level guarding protection when connecting to the DC input supply or Dynamic Brake Resistor terminals, only remove part of the upper terminal cover breakout, or provide suitable external guarding.

Frame H

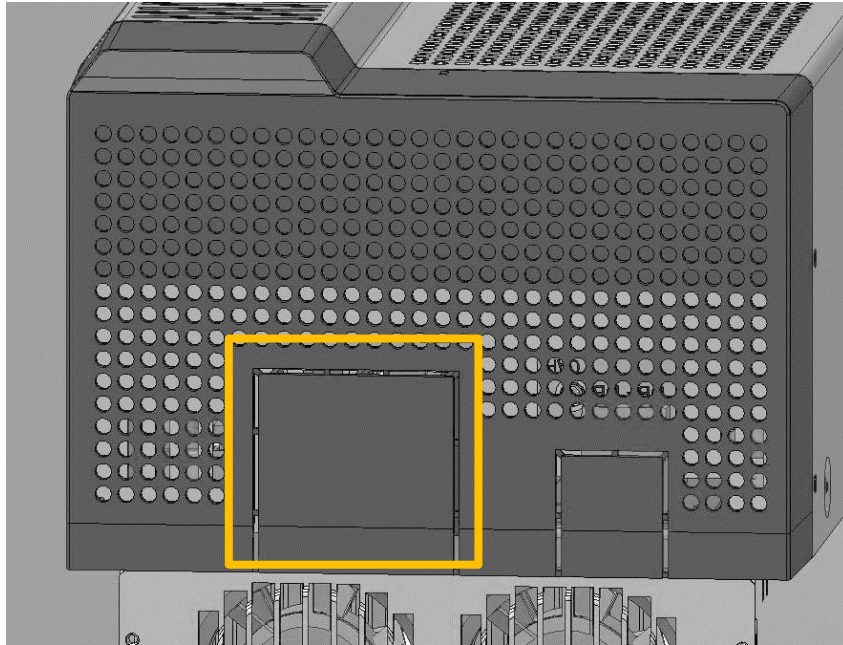

Top Terminal Cover

Frame J

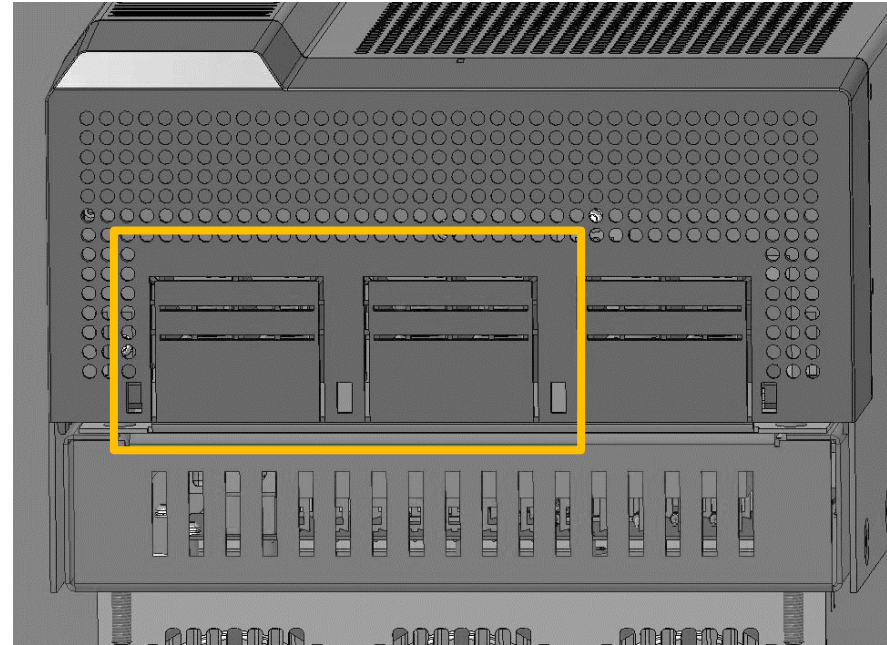

POWER STACK – Y-CAP & VDR DISCONNECTS

With the terminal covers removed (and in some instances the AC30 Control Module), customer accessible screws have been provided to disconnect either the AC line & DC link Y-capacitors from earth or the VDRs (line voltage suppressors) from earth.

These screws vary in location and in number between each Frame size.

It may be required to remove them in system applications where there are RCD's in circuit or where the inverter is installed on an IT supply:

WARNING



Disconnection of the EMC filter invalidates the CE EMC Declaration. The product becomes a component for incorporation and the conformity of the complete equipment or installation becomes the responsibility of the installer.

Refer to 'Appendix A: Compliance' for more information on conducted emissions EMC compliance.



Frame D

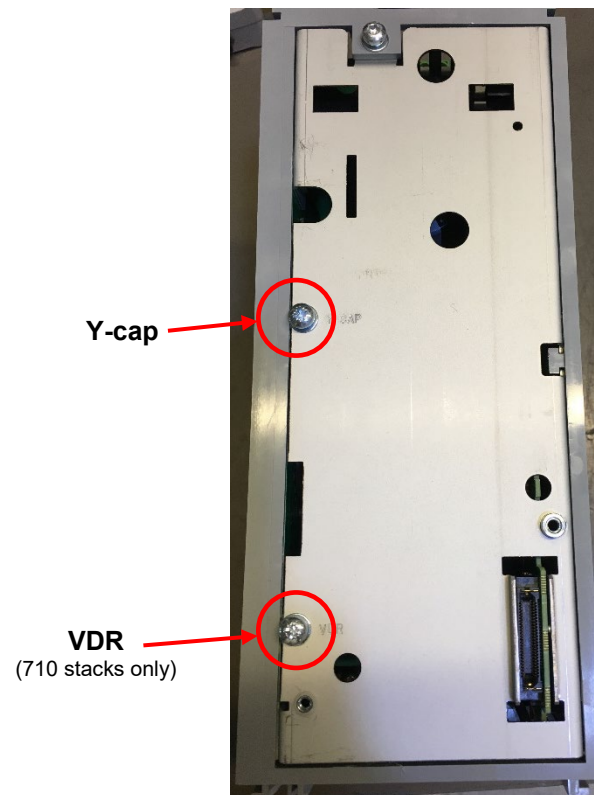

1. Remove the AC30 Control Module.
2. Remove as required:
 - 1x Y-cap disconnect
 - 1x VDR disconnect (710 stacks only)

4-22 Installation - Power Stack

Top Terminal Area

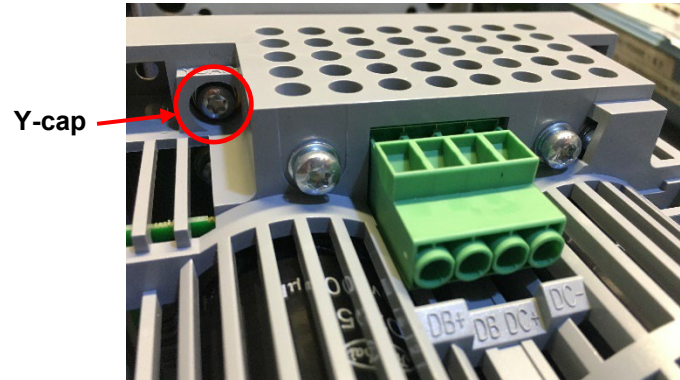

1. Remove the top terminal cover.
2. Remove as required:
 - 1x Y-cap disconnect

Frames E & F

Bottom Terminal Area

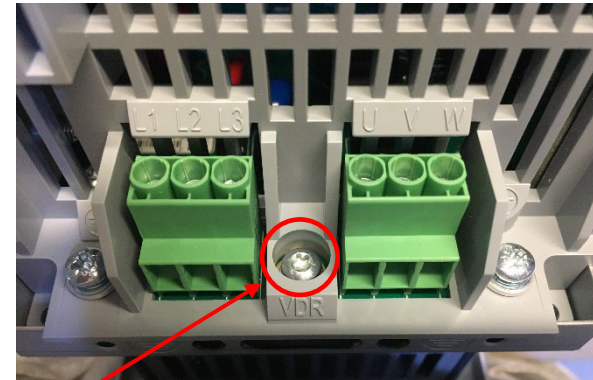

VDR
(710 stacks only)

1. Remove the bottom terminal cover.
2. Remove as required:
 - 1x VDR disconnect (710 stacks only)

Frame G

Top Terminal Area

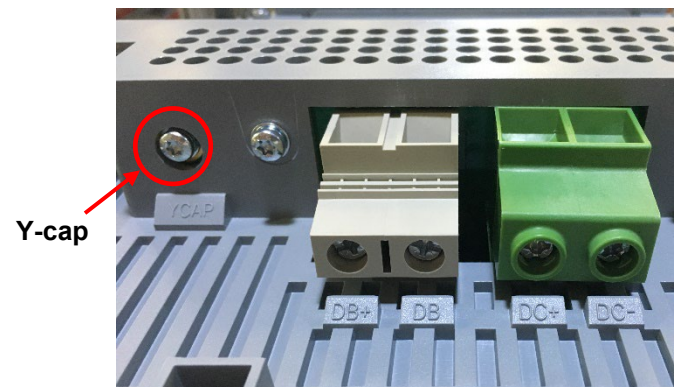

- 1. Remove the top terminal cover.
- 2. Remove as required:
 - 1x Y-cap disconnect

Bottom Terminal Area

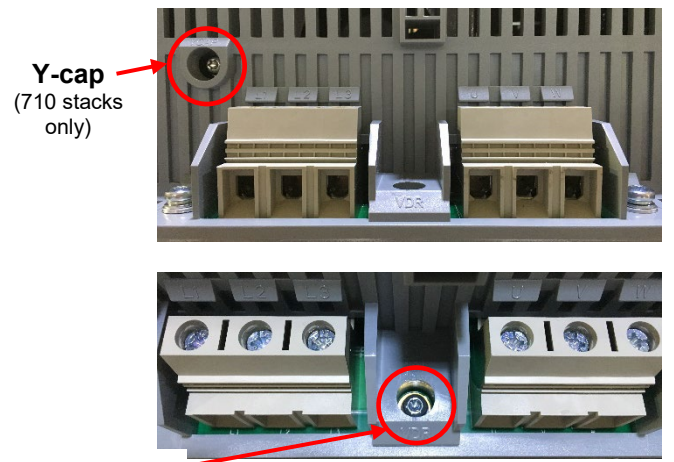

- 1. Remove the bottom terminal cover.
- 2. Remove as required:
 - 1x Y-cap disconnect (710 stacks only)
 - 1x VDR disconnect (710 stacks only)

4-24 Installation - Power Stack

Frame H

Top Terminal Area

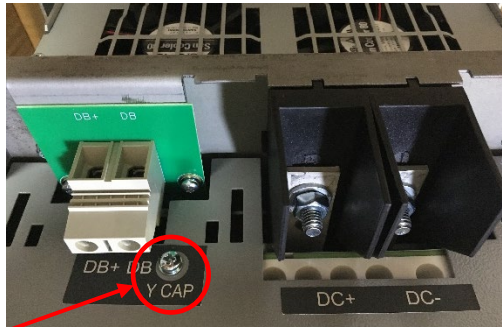

Y-cap

1. Remove the top terminal cover.
2. Remove as required:
 - 1x Y-cap disconnect

Bottom Terminal Area



VDR
(710 stacks only)

1. Remove the bottom terminal cover.
2. Remove as required:
 - 1x VDR disconnect (710 stacks only)

Control Module Area

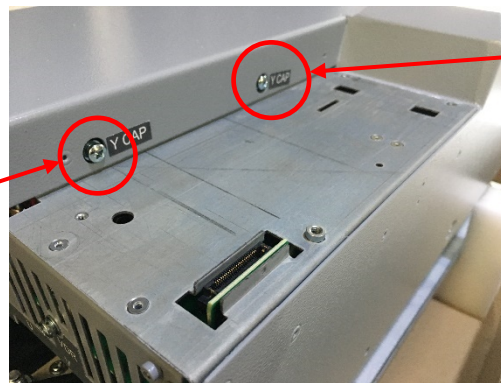

Y-cap 1
(710-4H0xxx-xF... stacks only)

Y-cap 2
(710-4H0xxx-xE... & 710-4H0xxx-xF... stacks only)

1. Remove the AC30 Control Module.
2. Remove as required:
 - 1x Y-cap 1 disconnect (710-4H0xxx-xF... stacks only)
 - 1x Y-cap 2 disconnect (710-4H0xxx-xE... & 710-4H0xxx-xF... stacks only)

Installation - Power Stack 4-25

Frame J

Top Terminal Area

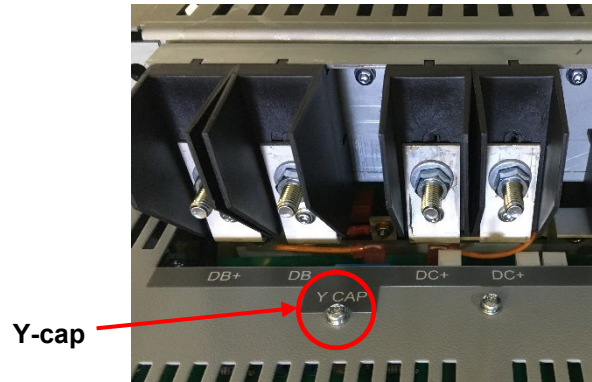

1. Remove the top terminal cover.
2. Remove as required:
 - 1x Y-cap disconnect

Bottom Terminal Area



1. Remove the bottom terminal cover.
2. Remove as required:
 - 1x VDR disconnect (710 stacks only)
 - 1x Y-cap disconnect (710 stacks only)

4-26 Installation - Power Stack

Chapter 5: Installation - Control Module

IMPORTANT Read 'Appendix A: Compliance' before installing this unit.

Control Module PRODUCT DIMENSIONS

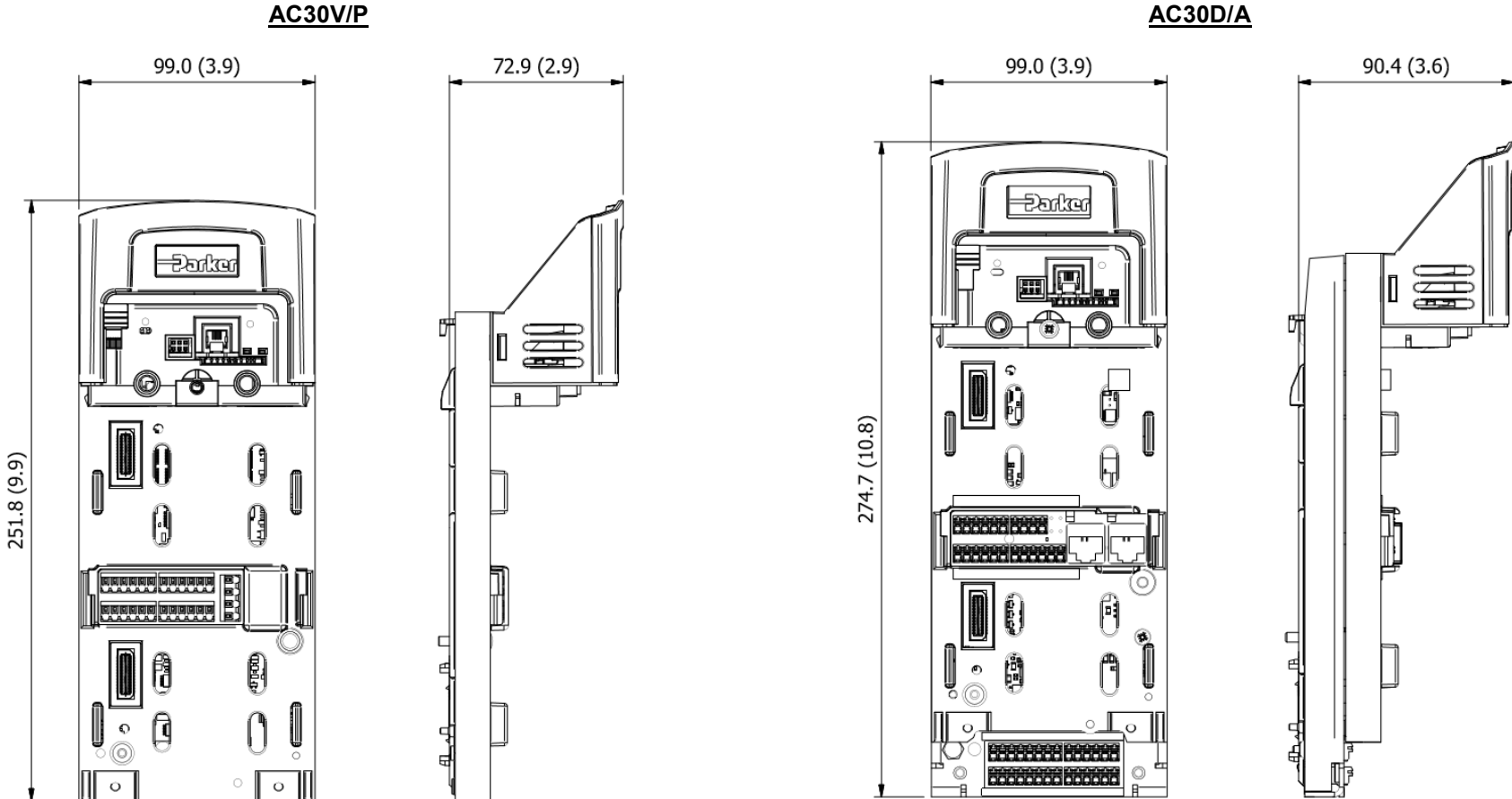

All dimensions are in millimetres (inches)

5-2 Installation - Control Module

Control Module Electrical Installation

IMPORTANT Please read the Safety Information in 'Chapter 1: Safety' before proceeding.

WIRING INSTRUCTIONS

Protective Earth (PE) Connections



It is important to earth the 0V of the control board to the PE connection outside of the inverter to meet both EMC and safety requirements. Refer to 'Appendix A: Compliance' for recommendations on PE connections.



DANGER – RISK OF ELECTRIC SHOCK

Terminal covers, main covers, and cover fixings must remain in place while the drive is energised. These should only be ever be removed once the supply to the unit has been disconnected, and the residual energy in the DC link capacitors has been discharged.



All activities covered in this chapter should be carried out when there is no power to the inverter.

If the drive has been powered up, ensure enough time has elapsed that the inverter has discharged it's residual energy.

Always check that the voltages on the user terminals are at a safe level (<50V) before carrying out any of these activities.

STO always overrides any attempt to start the inverter. If one or both STO control inputs is requesting the STO function, the inverter will not start, even if for example, the inverter's software malfunctions and tries to cause the motor to turn.

Refer to 'Chapter 8: Safe Torque Off SIL3/PLe' for further information.

CONTROL MODULE COVER REMOVAL

In order to gain access to the control wiring, or to fit either Option and/or Comms cards, cabling brackets and SD cards, or remove the control module altogether, first remove the control module cover as follows:

1. First remove the GKP (or Blanking Plate) by pulling on it from the top edge down.

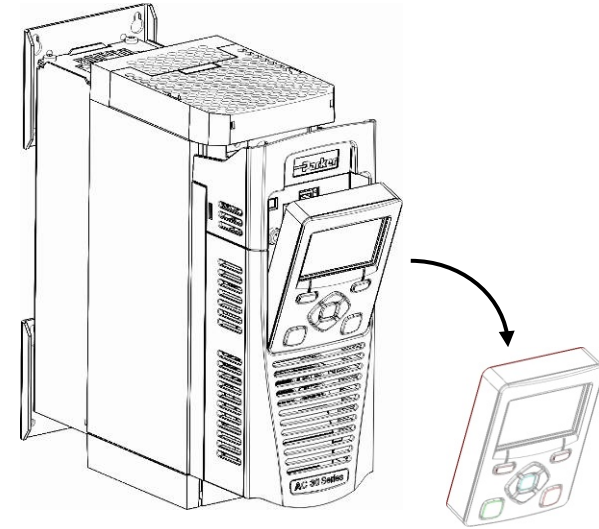

2. Undo the screw and slide the control module cover down slightly. This will then allow its removal.

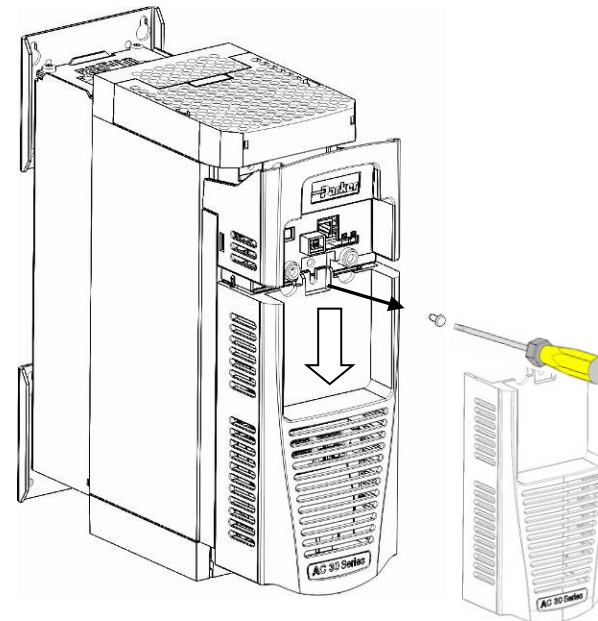

5-4 Installation - Control Module

CONTROL MODULE REMOVAL

If it is required that the control module is to be removed from the power stack, then having first removed the control module cover and Comms card (if fitted), as outlined on pages 5-3 and 5-28 respectively:

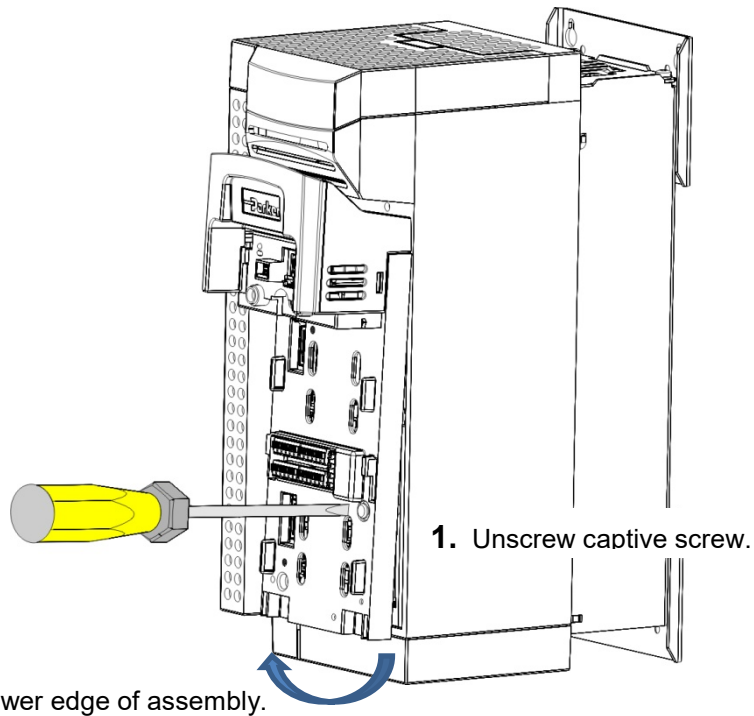

2. Lift lower edge of assembly.

Note that there are two screws used to retain the AC30D & AC30A control modules.

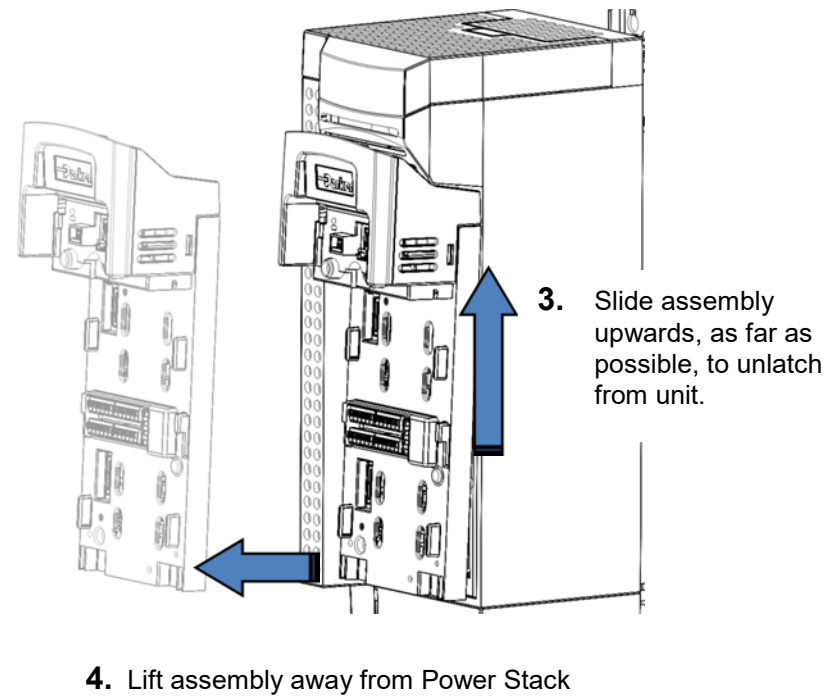
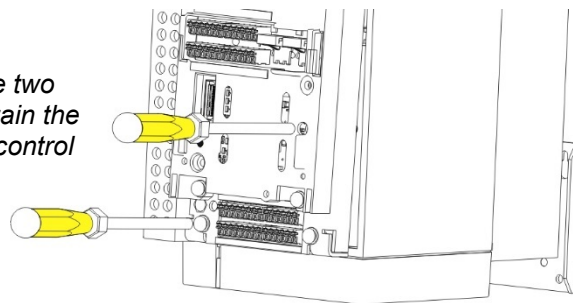

AC30V CONTROL WIRING CONNECTIONS

Terminal ID	Function
X10/01	STO A Input
X10/02	STO Common
X10/03	STO B Input
X10/04	STO Common
X10/05	STO Status A
X10/06	STO Status B
X11/01	ANIN 01 (+10V, 0-10V, 0-20mA, 4-20mA)
X11/02	ANIN 02 (+10V, 0-10V)
X11/03	ANOUT 01 (+10V, 0-10V)
X11/04	ANOUT 02 (0-10V, 0-20mA, 4-20mA)
X11/05	+10V reference
X11/06	-10V reference
X12/01 (LH)	DIGIN 04 / DIGOUT 01
X12/02	DIGIN 05 / DIGOUT 02
X12/03	DIGIN 06 / DIGOUT 03
X12/04	DIGIN 07 / DIGOUT 04
X12/05	User +24V output
X12/06	0V
X13/01 (LH)	0V
X13/02	DIGIN 01
X13/03	DIGIN 02
X13/04	DIGIN 03
X13/05	+24V AUX input
X13/06	0V AUX input
X14/01 (BOT)	Relay 01 (contact A)
X14/02	Relay 01 (contact B)
X14/03	Relay 02 (contact A)
X14/04	Relay 02 (contact B)

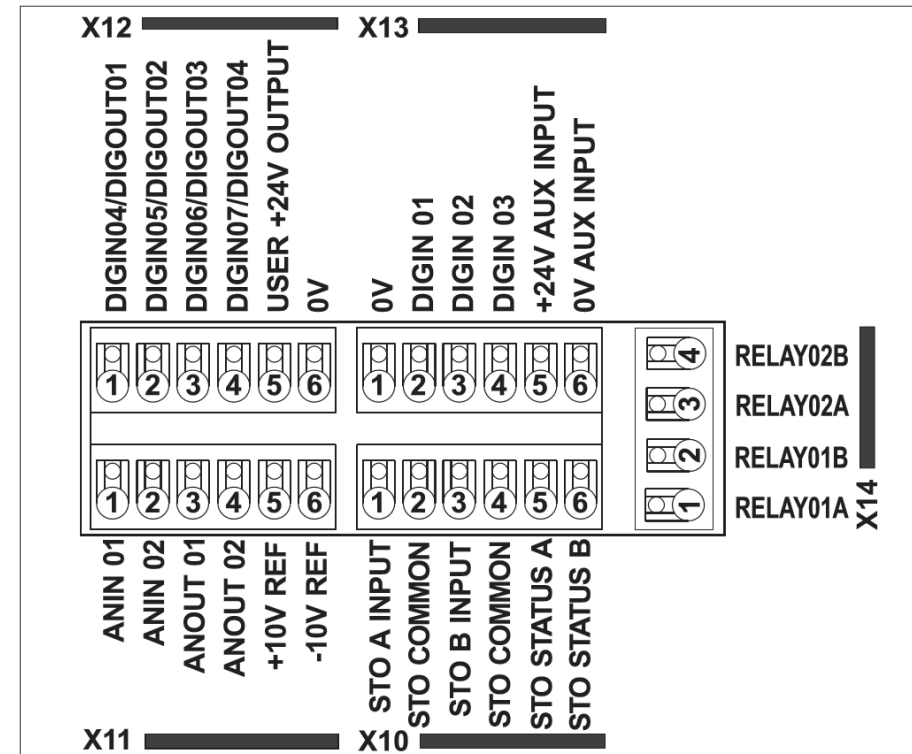

5-6 Installation - Control Module

AC30P, AC30D & AC30A - CONTROL WIRING CONNECTIONS

Terminal ID	Function
X10/01	STO A Input
X10/02	STO Common
X10/03	STO B Input
X10/04	STO Common
X10/05	STO Status A
X10/06	STO Status B
X11/01	ANIN 01 (+10V, 0-10V, 0-20mA, 4-20mA)
X11/02	ANIN 02 (+10V, 0-10V)
X11/03	ANOUT 01 (+10V, 0-10V)
X11/04	ANOUT 02 (0-10V, 0-20mA, 4-20mA)
X11/05	+10V reference
X11/06	-10V reference
X12/01 (LH)	DIGIN 04 / DIGOUT 01
X12/02	DIGIN 05 / DIGOUT 02
X12/03	DIGIN 06 / DIGOUT 03
X12/04	DIGIN 07 / DIGOUT 04
X12/05	User +24V output
X12/06	0V
X13/01 (LH)	0V
X13/02	DIGIN 01
X13/03	DIGIN 02
X13/04	DIGIN 03
X13/05	+24V AUX input (AC30P only)
X13/06	0V AUX input (AC30P only)
Ethernet Port 1	
Ethernet Port 2	

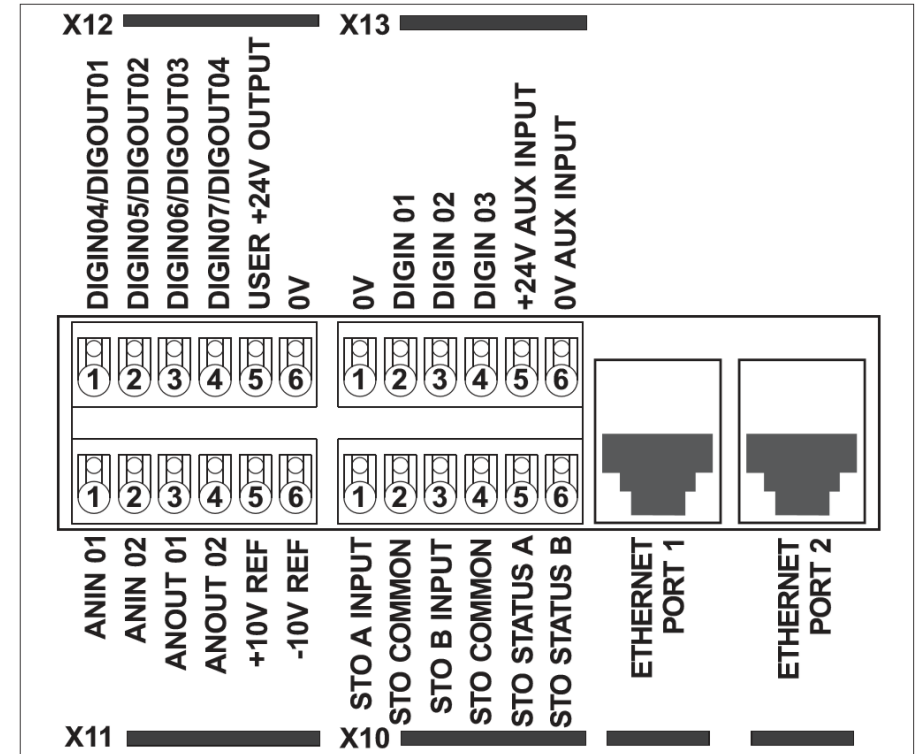

SYSTEM BOARD CONTROL WIRING CONNECTIONS (AC30D ONLY)

Terminal ID	Function
X30/01	SB DIGIN 01
X30/02	SB DIGIN 02
X30/03	SB DIGIN 03
X30/04	SB DIGIN 0V
X30/05	+24V System Aux. Input
X30/06	0V System Aux. Input
X31/01	Encoder 2 – A input
X31/02	Encoder 2 – /A input
X31/03	Encoder 2 – B input
X31/04	Encoder 2 – /B input
X31/05	Encoder 2 – Z input
X31/06	Encoder 2 – /Z input
X31/07	Encoder PSU Output – Positive terminal
X31/08	Encoder PSU Output – 0V terminal
X32/01	Encoder 1 – A input
X32/02	Encoder 1 – /A input
X32/03	Encoder 1 – B input
X32/04	Encoder 1 – /B input
X32/05	Encoder 1 – Z input
X32/06	Encoder 1 – /Z input
X32/07	Encoder PSU Output – Positive terminal
X32/08	Encoder PSU Output – 0V terminal
X33/01	Encoder Transmit – A output
X33/02	Encoder Transmit – /A output
X33/03	Encoder Transmit – B output
X33/04	Encoder Transmit – /B output
X33/05	Encoder Transmit – Z output
X33/06	Encoder Transmit – /Z output

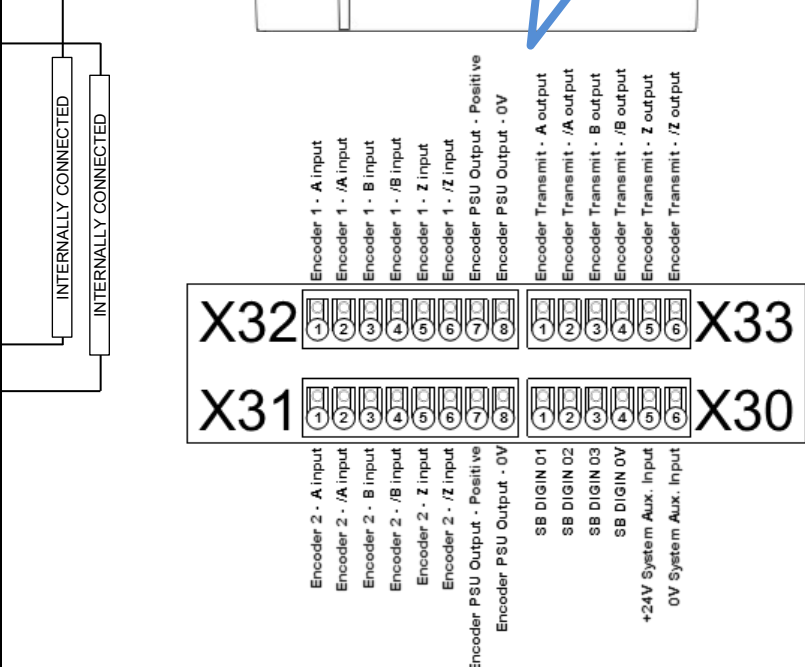
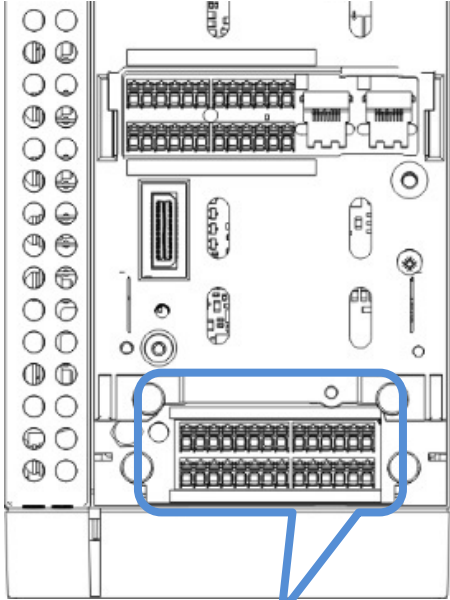

5-8 Installation - Control Module

SYSTEM BOARD CONTROL WIRING CONNECTIONS (AC30A ONLY)

Terminal ID	Function
X30/01	SB DIGIN 01
X30/02	SB DIGIN 02
X30/03	SB DIGIN 03
X30/04	SB DIGIN 0V
X30/05	+24V System Aux. Input
X30/06	0V System Aux. Input
X33/01	Encoder Transmit – A output
X33/02	Encoder Transmit – /A output
X33/03	Encoder Transmit – B output
X33/04	Encoder Transmit – /B output
X33/05	Encoder Transmit – Z output
X33/06	Encoder Transmit – /Z output
X34/01	RS485 Endat Data+
X34/02	RS485 Endat Data-
X34/03	RS485 Endat Clock+
X34/04	RS485 Endat Clock-
X34/05	SB DIGIN 04 / SB DIGOUT 01
X34/06	SB DIGIN 05 / SB DIGOUT 02
X34/07	SB DIGIN 06 / SB DIGOUT 03
X34/08	0V
X35/01	Encoder – Sin+ input (Heidenhain B+)
X35/02	Encoder – Sin- input (Heidenhain B-)
X35/03	Encoder – Cos+ input (Heidenhain A+)
X35/04	Encoder – Cos- input (Heidenhain A-)
X35/05	Encoder – Z input
X35/06	Encoder – /Z input
X35/07	Encoder PSU Output – Positive terminal
X35/08	Encoder PSU Output – 0V terminal

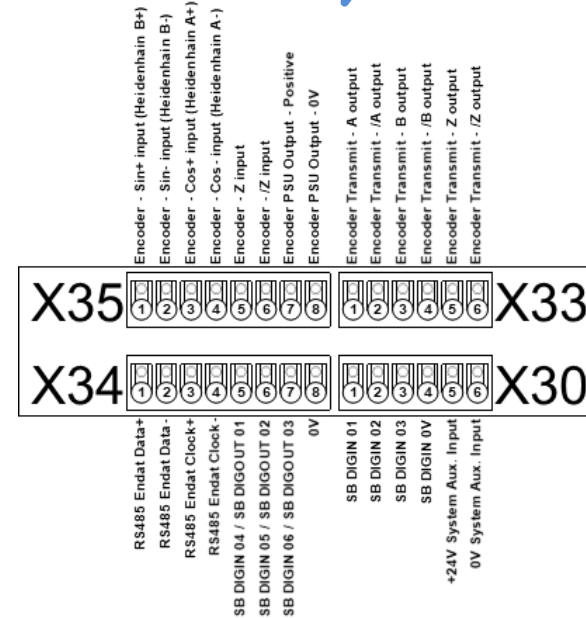
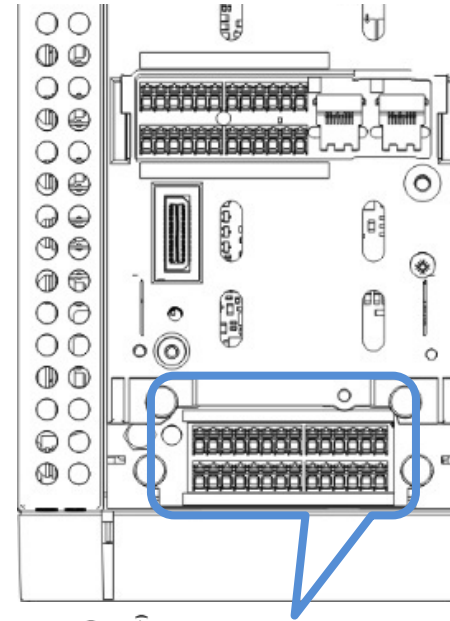

SYSTEM BOARD ENCODER WIRING DIAGRAM (AC30A ONLY)

Parker recommend that customers connect up to the AC30A system board as follows:

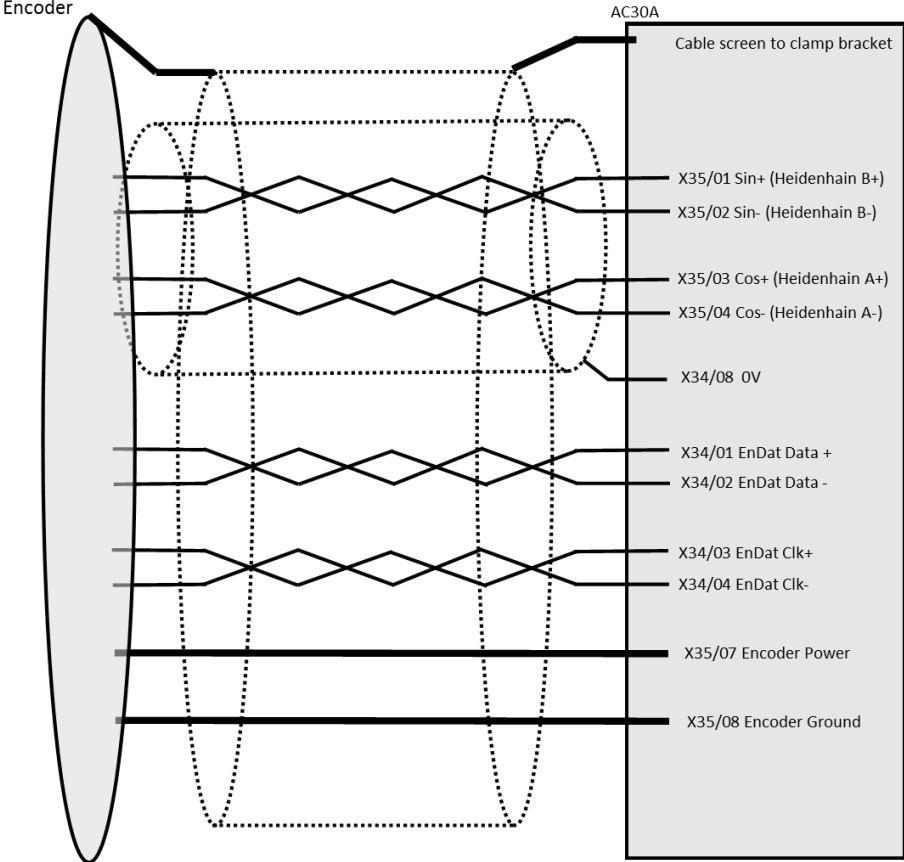

5-10 Installation - Control Module

Wiring Diagrams

THE DEFAULT APPLICATION

The AC30V inverter is supplied with 5 Applications, Application 0 to Application 4. Each Application recalls a pre-programmed structure of internal links when it is loaded.

- Application 0 is the factory default application, providing for basic speed control
- Application 1 supplies speed control using a manual or auto setpoint
- Application 2 is a set-up providing speed control with Raise/Lower Trim
- Application 3 supplies speed control using preset speeds
- Application 4 PID control

The AC30P, AC30D and AC30A inverters are supplied with 2 Applications, Application 0 and Application 5. Each Application recalls a pre-programmed structure of internal links when it is loaded.

Application 0 is the factory default application, providing for basic speed control.

Application 5 supports the use of the inverter as an Active Front-End for regenerative applications.

IMPORTANT: *Refer to 'Chapter 9: The Graphical Keypad' for details on how to reset the inverter to factory default values which are suitable for most applications.*

APPLICATION DESCRIPTION

Control Wiring for Applications

The large Application Diagrams on the following pages show the full wiring for push-button starting. The other diagrams show the full wiring for single wire starting.

When you load an Application, the input and output parameters shown in these diagrams default to the settings shown. For alternative user-settings refer to the HA503711U003 'Chapter 6: Setup Wizard'.

Local Control Wiring

This is the simplest installation. Every new inverter will operate in Local Control when first powered-up. The keypad is used to start and stop the inverter.

Refer to the Connection Diagram and install the:

- STO (factory fitted)
- Motor cable
- Supply cable
- Follow the earthing/grounding and screening advice

Refer to HA503711U003 'Chapter 6: Setup Wizard'.

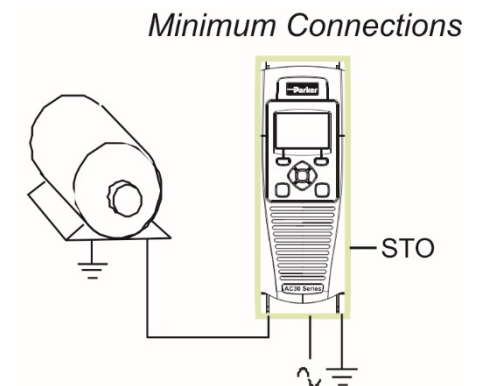

Remote Control Wiring

If operating in Remote Control you will use your control panel to start and stop the inverter, via a speed potentiometer and switches or push-buttons.

Your wiring of the control terminals will be governed by the Application you use: refer to the various Applications you can select and the appropriate control wiring. Application 0 is the default Application.

The diagram below shows the **minimum** connections to operate the inverter for single-wire (switch) starting, and push-button starting. Other control connections for your Application, can be made to suit your system.

Referring to the Connection Diagram:

- Follow the instructions for Local Control Wiring, as detailed above
- Install using minimum connections (suitable for Application 0 only), or refer to the appropriate control wiring for your system.

Note: You can still operate the inverter in Local mode, if necessary, with any Application selected.

This application is ideal for general purpose applications. It provides push-button or switched start/stop control. The setpoint is the sum of the two analogue inputs AIN1 and AIN2, providing Speed Setpoint + Speed Trim capability.

Minimum Connections for Application 0

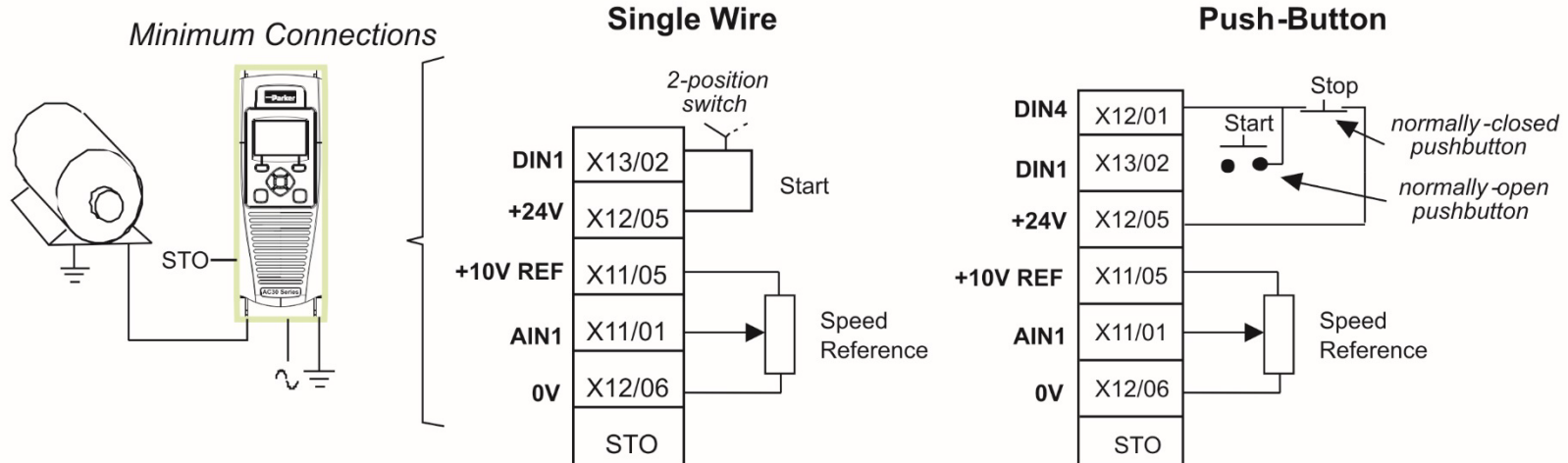

5-12 Installation - Control Module

APPLICATION 0: BASIC SPEED CONTROL

Ideal for general purpose applications, normal duty and heavy duty

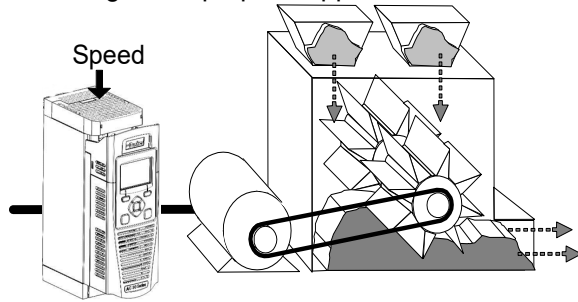

Application 0:

“Basic Speed Control”

IDEAL FOR GENERAL PURPOSE APPLICATIONS,
NORMAL DUTY AND HEAVY DUTY

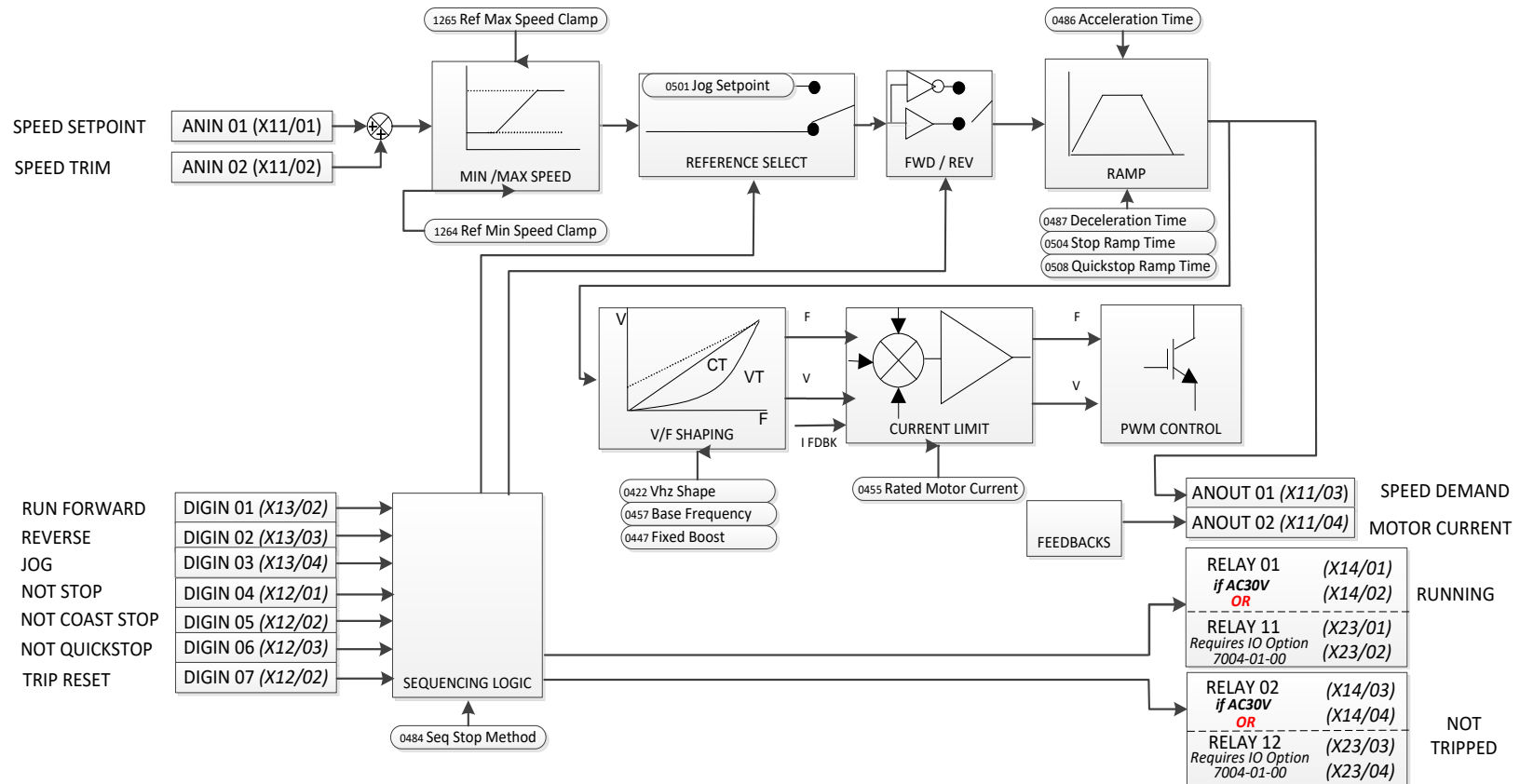

Basic Speed Control Wiring

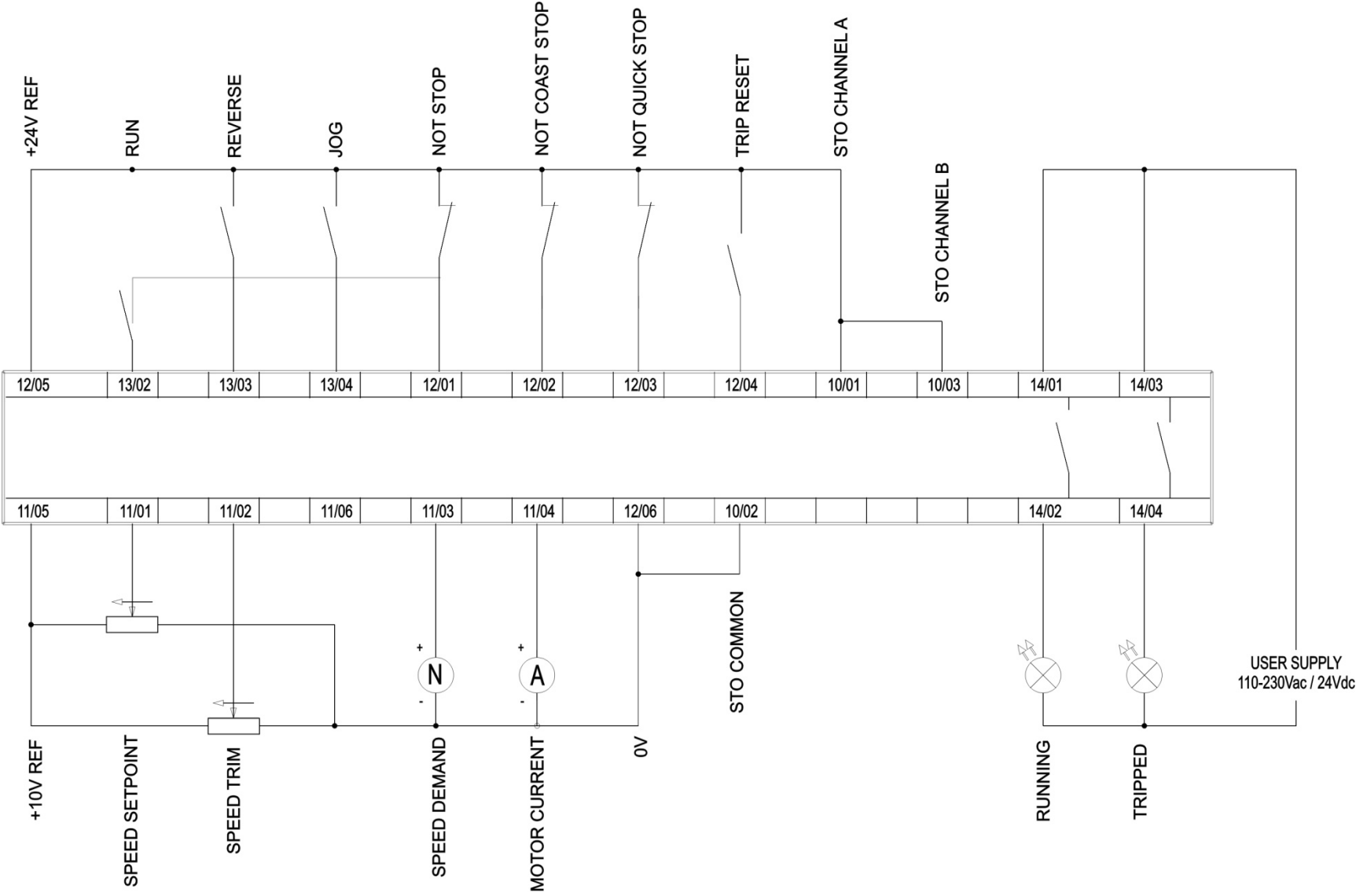

5-14 Installation - Control Module

APPLICATION 1: AUTO/MANUAL CONTROL

Ideal for automatic control applications with limit switches or proximity transducers

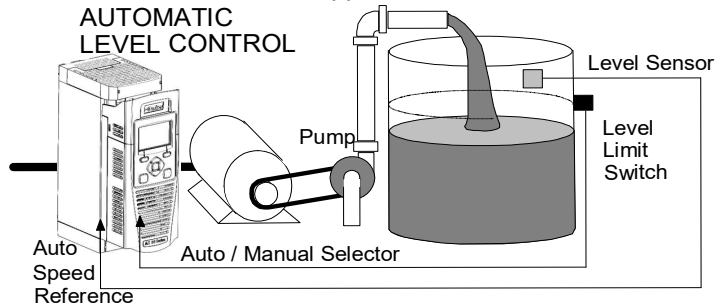

Application 1:
“Auto/Manual Control”
 IDEAL FOR AUTOMATIC CONTROL
 APPLICATIONS WITH LIMIT SWITCHES OR
 PROXIMITY TRANSDUCERS

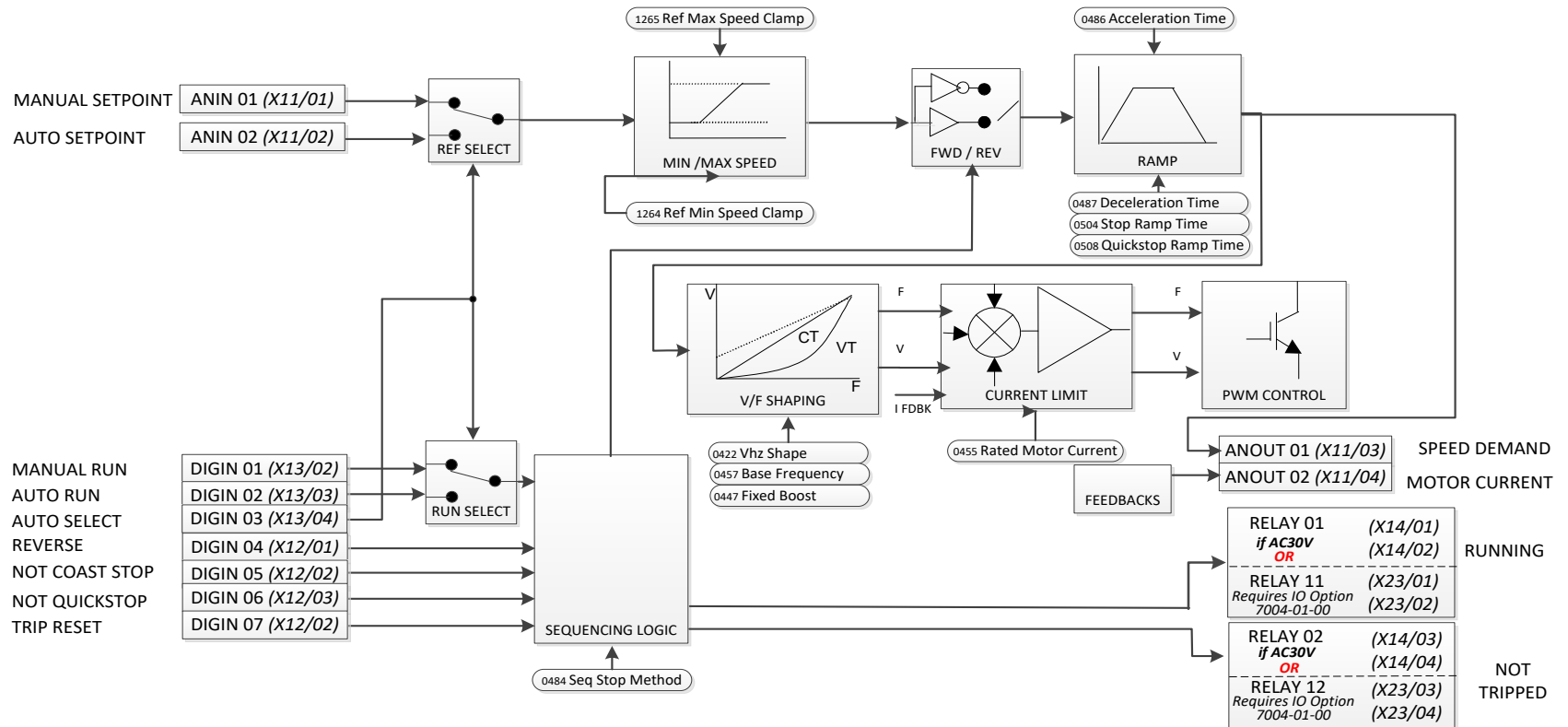

Auto/Manual Control Application

Two Run inputs and two Setpoint inputs are provided. The Auto/Manual switch selects which pair of inputs is active. The Application is sometimes referred to as Local/Remote.

Auto/Manual Control Wiring

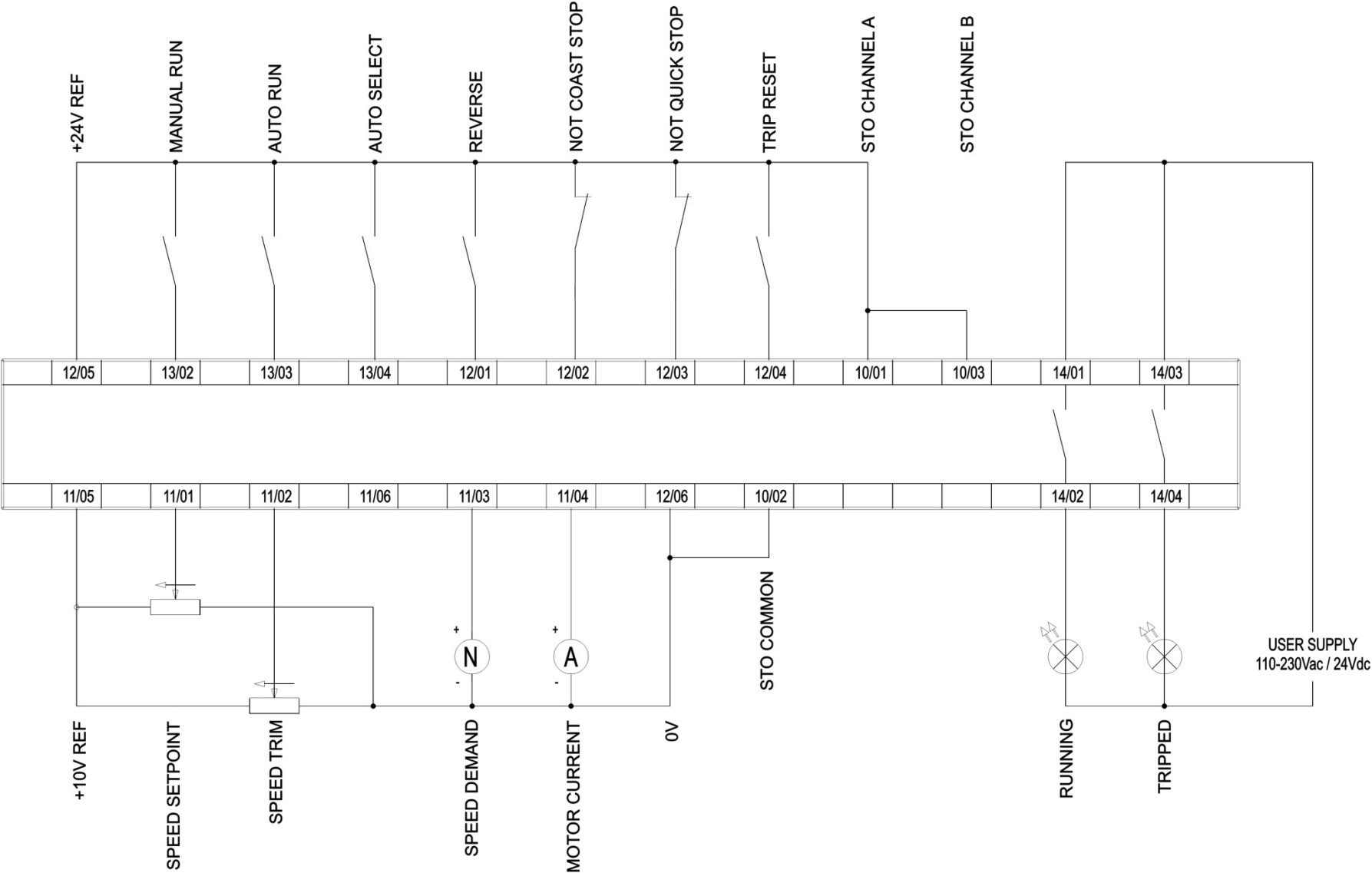

5-16 Installation - Control Module

APPLICATION 2: RAISE / LOWER TRIM

Ideal for applications requiring speed control from multiple locations

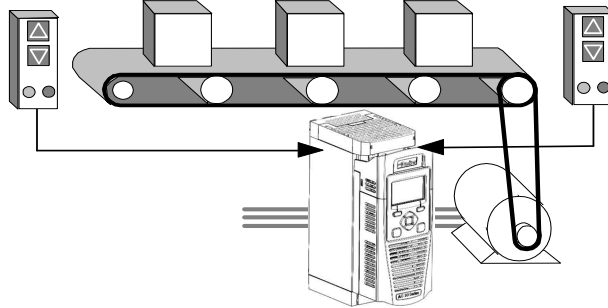

Application 2:
“Speed Raise/Lower”
 IDEAL FOR APPLICATIONS REQUIRING SPEED CONTROL FROM MULTIPLE LOCATIONS

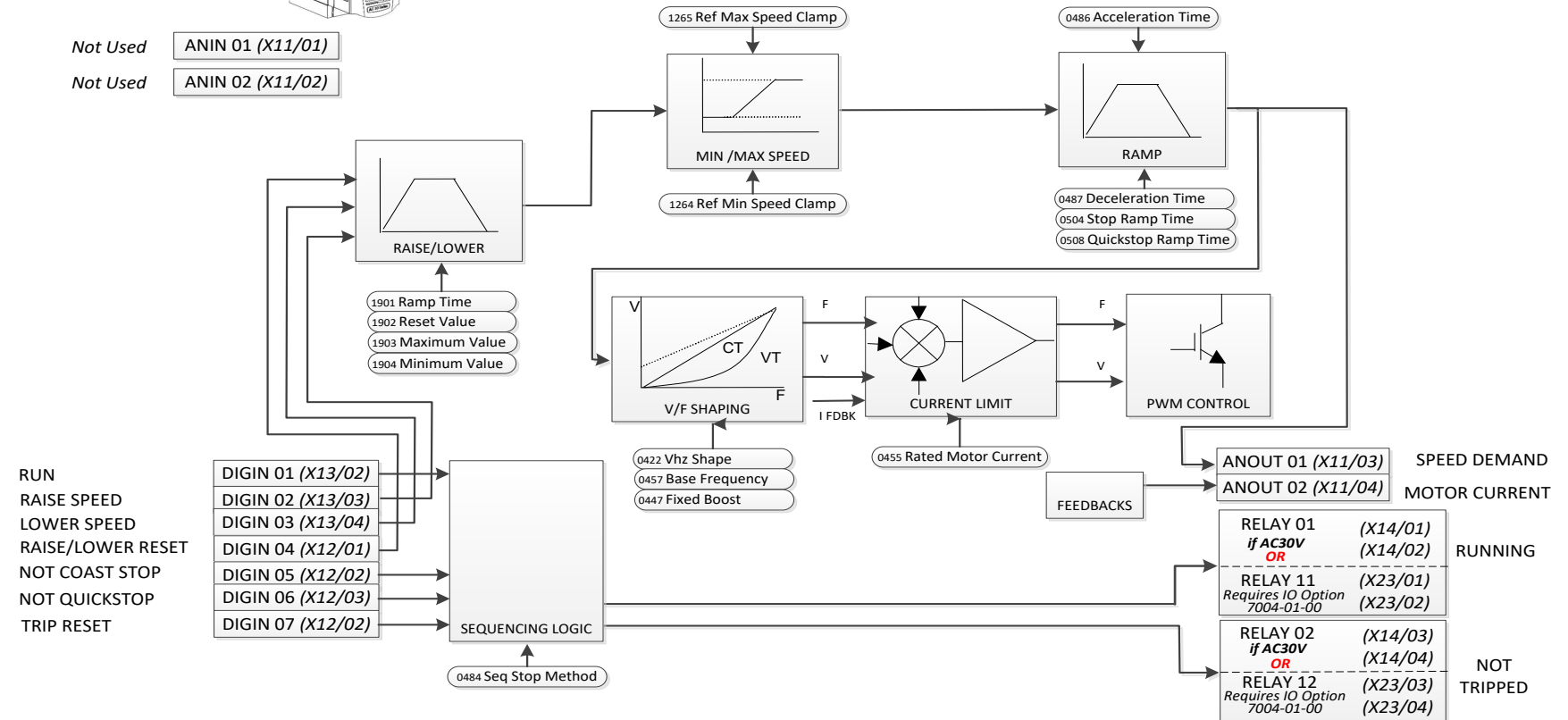

Raise/Lower Trim Application

This Application mimics the operation of a motorised potentiometer. Digital inputs allow the setpoint to be increased and decreased between limits. The limits and ramp rate can be set using the keypad.

The Application is sometimes referred to as Motorised Potentiometer.

Raise/Lower Trim Wiring

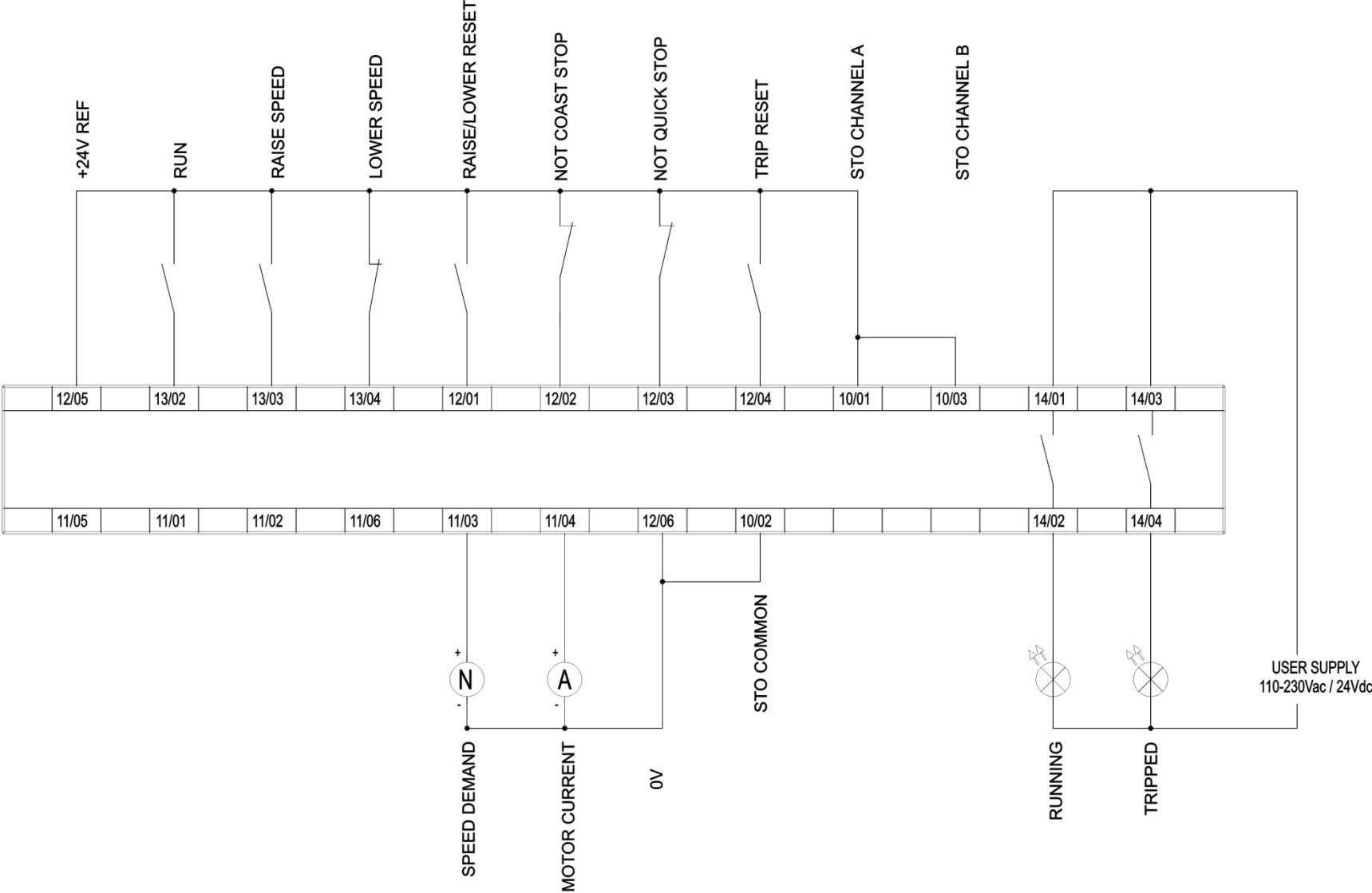

5-18 Installation - Control Module

APPLICATION 3: PRESETS SPEEDS

Ideal for general purpose applications requiring multiple speed levels

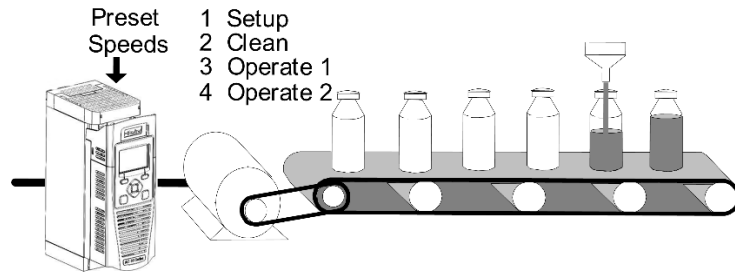

Application 3:
“Speed Presets”
 IDEAL FOR GENERAL PURPOSE APPLICATIONS
 REQUIRING MULTIPLE DISCRETE SPEED LEVELS

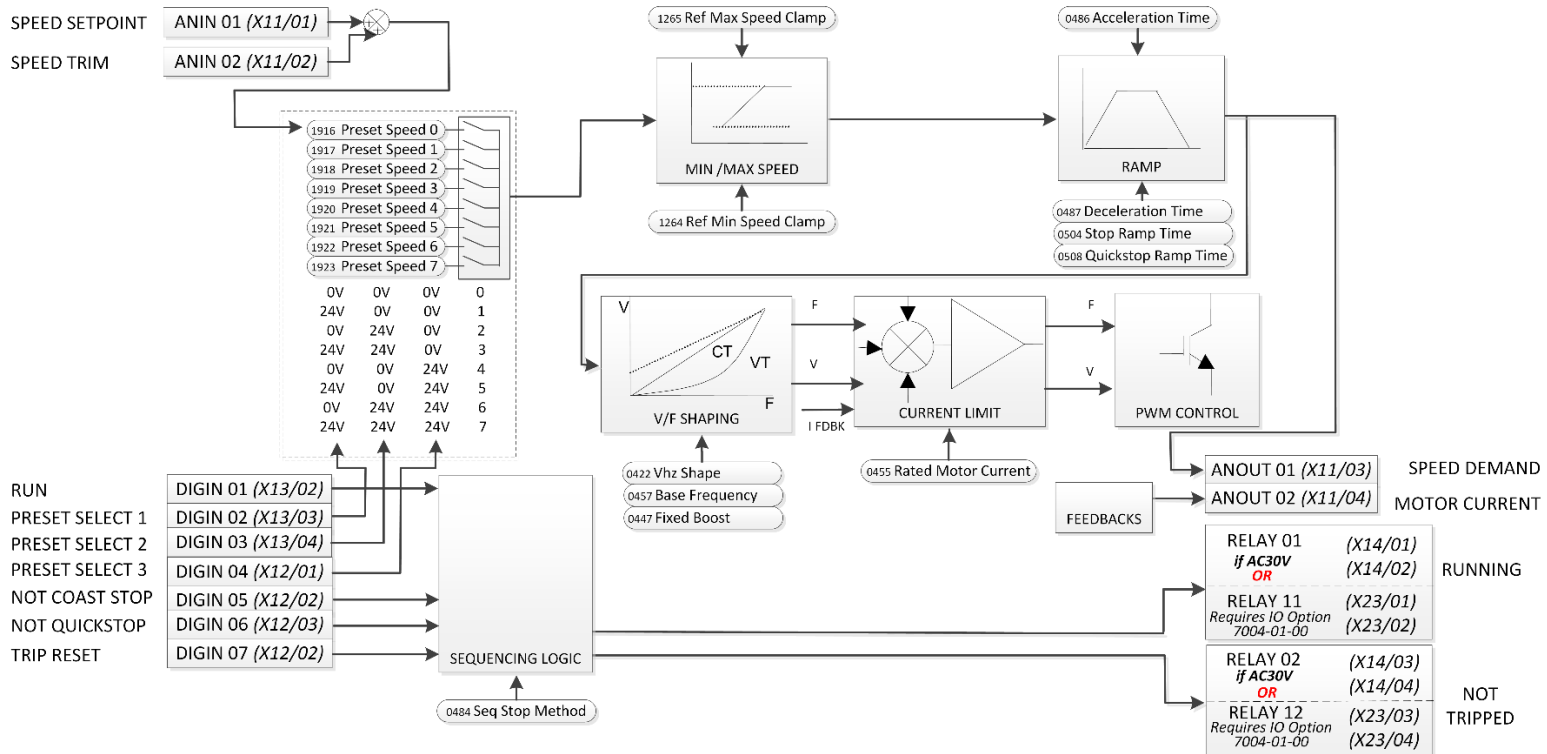

Presets Speeds Application

This is ideal for applications requiring multiple discrete speed levels.

The setpoint is selected from either the sum of the analogue inputs, (as in Application 1 and known here as PRESET 0), or as one of up to seven other pre-defined speed levels. These are selected using DIN2, DIN3 and DIN4, refer to the Truth Table above.

Edit parameters P1917 to P1923 on the keypad to re-define the speed levels of PRESET 1 to PRESET 7. Reverse direction is achieved by entering a negative speed setpoint.

Presets Speeds Wiring

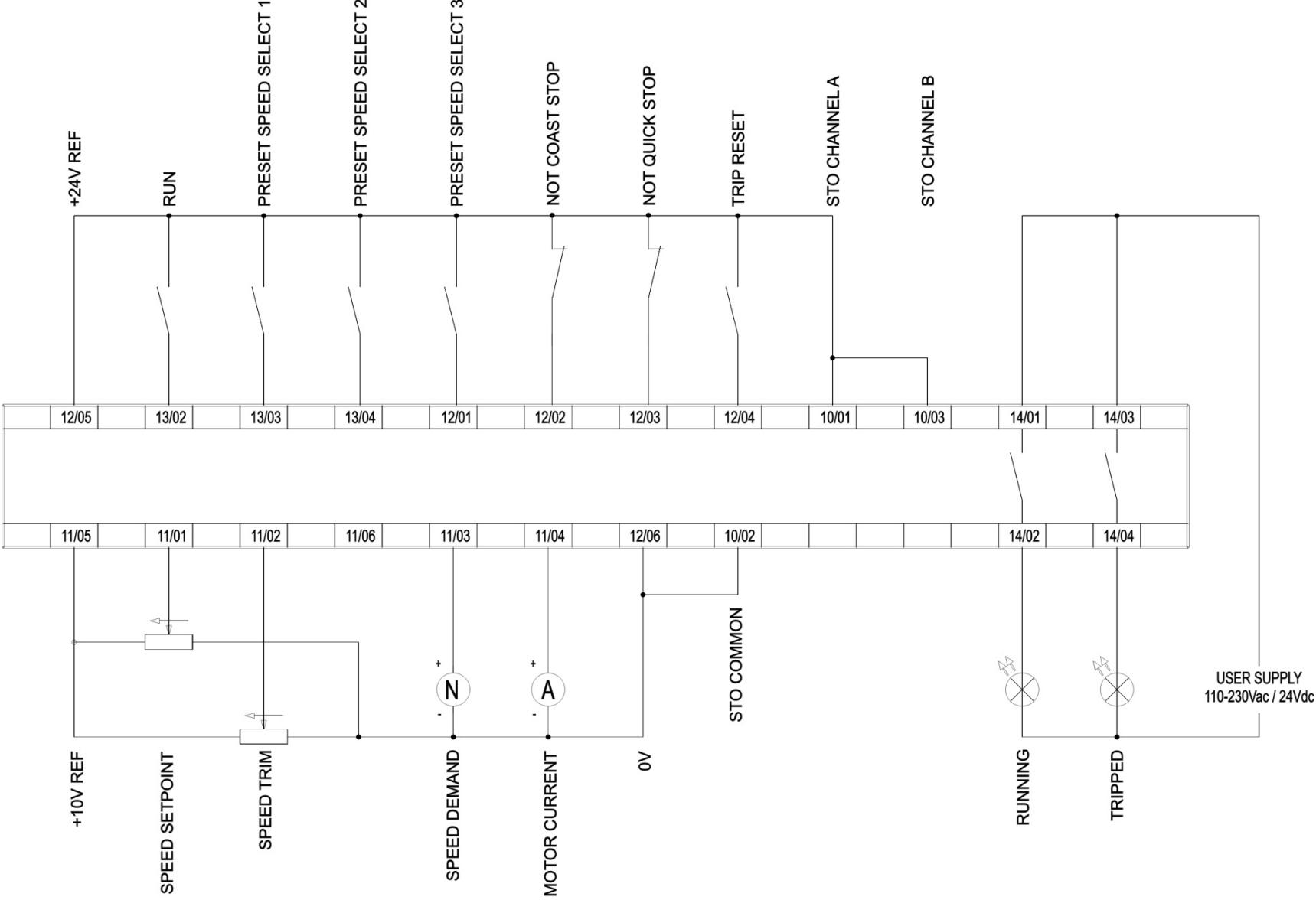

5-20 Installation - Control Module

APPLICATION 4: PID CONTROL

Easy Tuning for setpoint/feedback control applications regulating volume or pressure, such as air handling or pumping

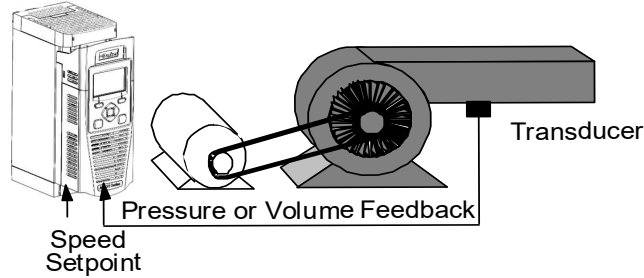

Application 4: "Process PID"

EASY TUNING FOR SETPOINT/FEEDBACK CONTROL APPLICATIONS REGULATING VOLUME OR PRESSURE, SUCH AS AIR HANDLING OR PUMPING

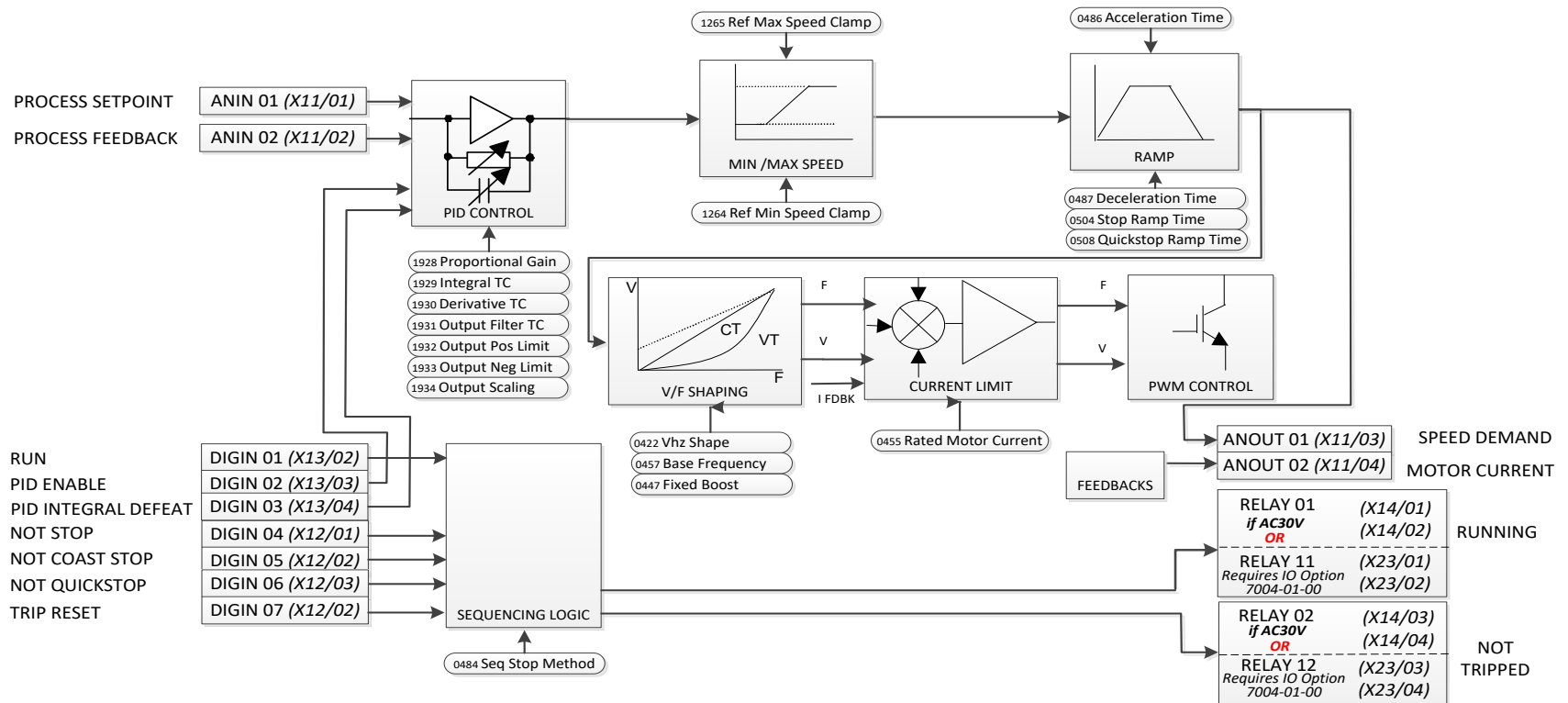

PID Control Application

A simple application using a Proportional-Integral-Derivative 3-term controller. By default the setpoint is taken from AIN1, with feedback signal from the process on AIN2, scaling parameter 1939 swaps the routing of AIN1 & 2. The scale and offset features of the analogue input blocks may be used to correctly scale these signals. The difference between these two signals is taken as the PID error. The output of the PID block is then used as the inverter setpoint.

PID Control Wiring

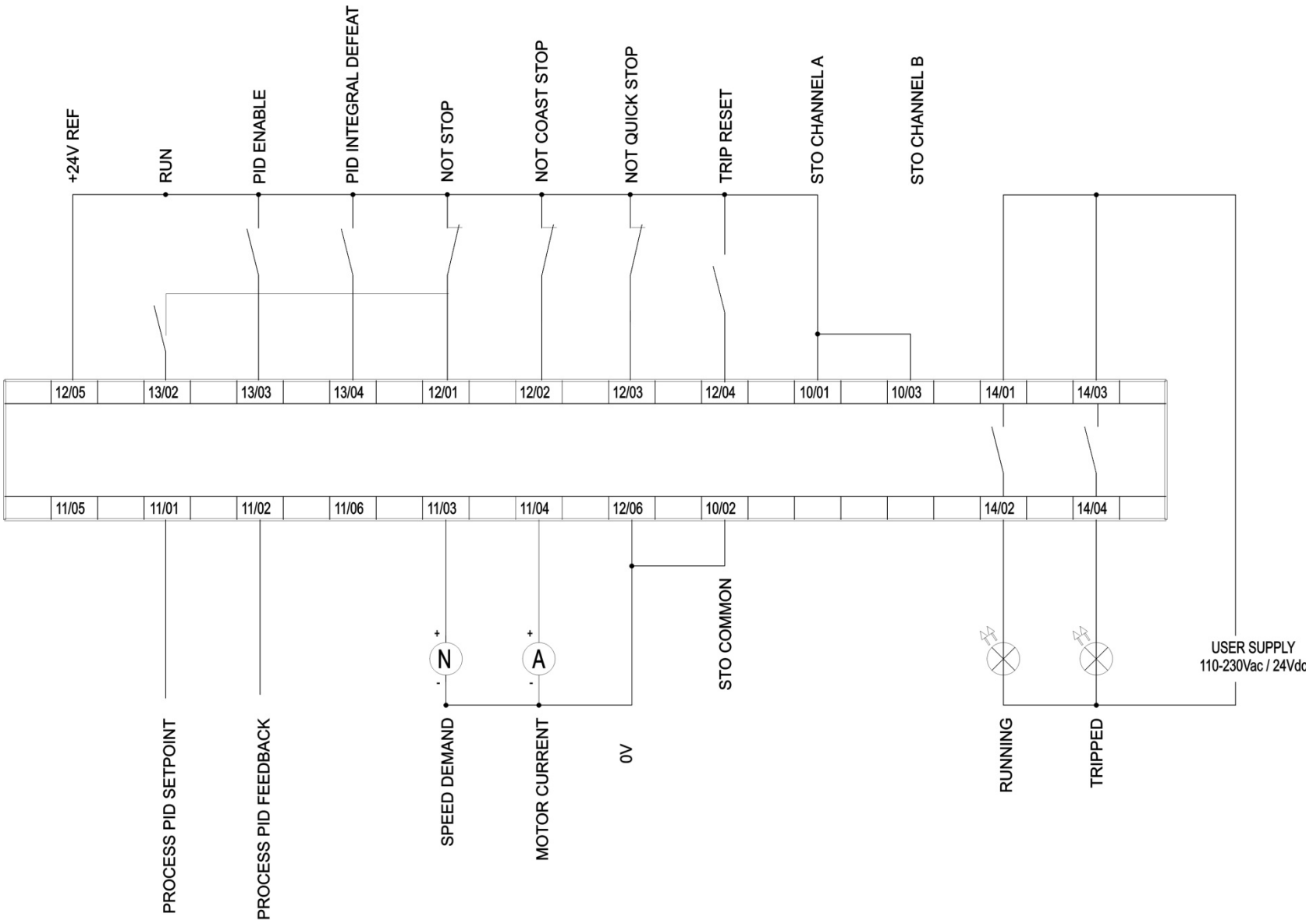

5-22 Installation - Control Module

APPLICATION 5: ACTIVE FRONT-END

Active Front End application that allows the drive to perform regeneration control of external precharge switches and contactors.

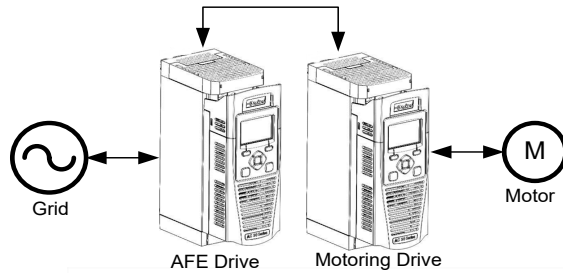

Application 5: "AFE"

ACTIVE FRONT END APPLICATION THAT ALLOWS THE DRIVE TO PERFORM REGENERATION OF ENERGY BACK INTO THE GRID, AND EXECUTES CONTROL OF EXTERNAL PRECHARGE SWITCHES AND CONTACTORS

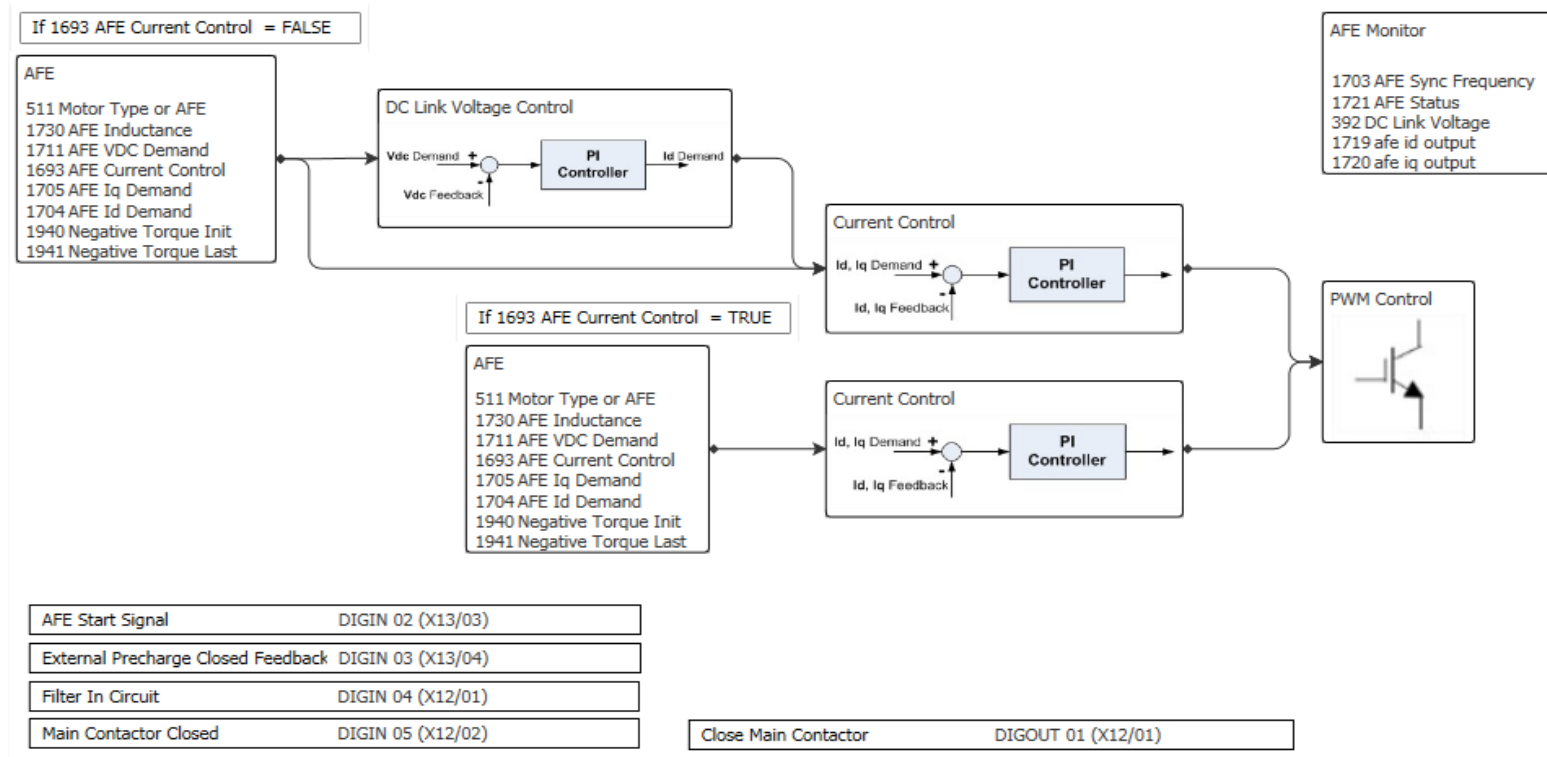

AFE Control Application

A simple application that controls external precharge relays and contactors, and ensures that all pre-requisites for regenerative operation of the drive are satisfied. If the drive is used as an active front end this application MUST be loaded and enabled. If the shown control wiring to the control card terminals is correct no further modification to the application is needed to be able to run in AFE mode. (The line sync card needs to be wired to the encoder option too.)

AFE Control Wiring – Excludes 7004-04-00 Wiring

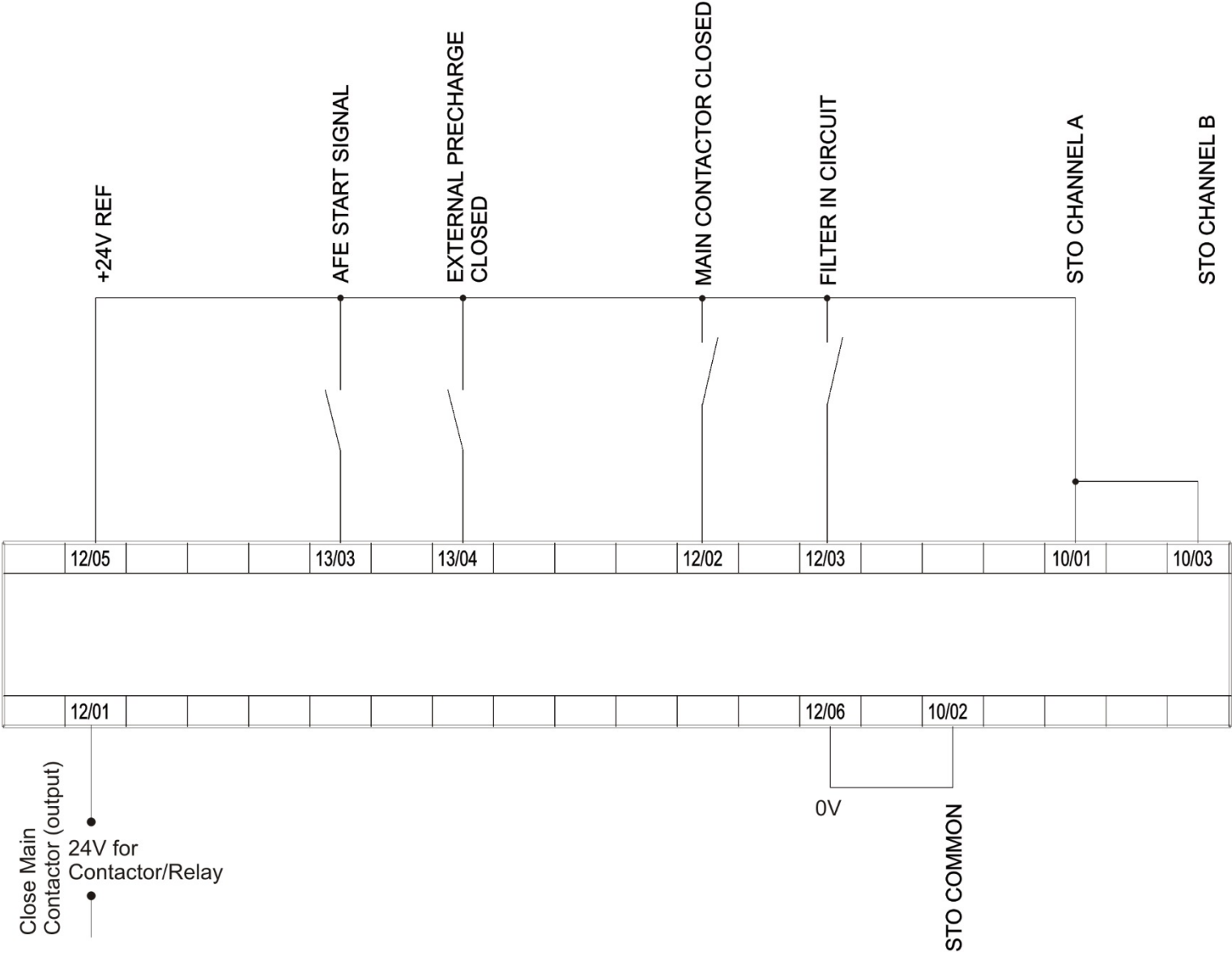

5-24 Installation - Control Module

CONTROL MODULE TERMINAL BLOCK WIRE RANGE

Wire sizes for Europe should be chosen with respect to the operating conditions and your local National Electrical Safety Installation Requirements. Local wiring regulations always take precedence.

Control Module	Control Terminals
AC30V	0.229 – 2.5 mm ²
AC30P	
AC30D	
AC30A	

CONTROL MODULE TERMINAL BLOCK CABLE & FERRULE RECOMMENDATIONS

The following wire is recommended for use with the AC30 series control module terminal blocks:

Wire Type	Core	Min	Max
H05(07)V-U	Solid	0.2 mm ²	1.5 mm ²
H05(07)V-K	Flexible	0.2 mm ²	1.5 mm ²

It is also recommended that the following ferrules are used in conjunctions with the recommended wires:

Ferrule Type	Standard	Wire Size		Ferrule Length	Parker Recommended Parts	
		Min	Max		Part No.	Description
Non insulated	DIN 46228 Part 1	0.2 mm ²	1.5 mm ²	≥ 8 mm	-	-
Insulated (plastic collar)	DIN 46228 Part 4	0.2 mm ²	0.75 mm ²	≥ 8 mm	CI053612U001	0.5 mm ² wire, 8 mm ferrule, orange collar
					CI053612U002	0.75 mm ² wire, 8 mm ferrule, white collar

CONTROL MODULE CABLING BRACKET (OPTIONAL)

Cabling brackets are available for the AC30 series control modules. These are listed in the 'Chapter 7: Associated Equipment – Control Module' section.

Note: For the AC30D & AC30A, the cable bracket must be fitted in order to meet EMC compliance.

The alternative to this solution, is for the user to provide a local earth bracket for the feedback cable screen connection, as well as a means of guarding the user terminals.

Cabling Brackets:

1. Remove the GKP/Blanking Plate (if fitted) and control module cover as instructed on page 5-3.
2. Secure the Cabling Bracket to the control module casting using the fixings provided.

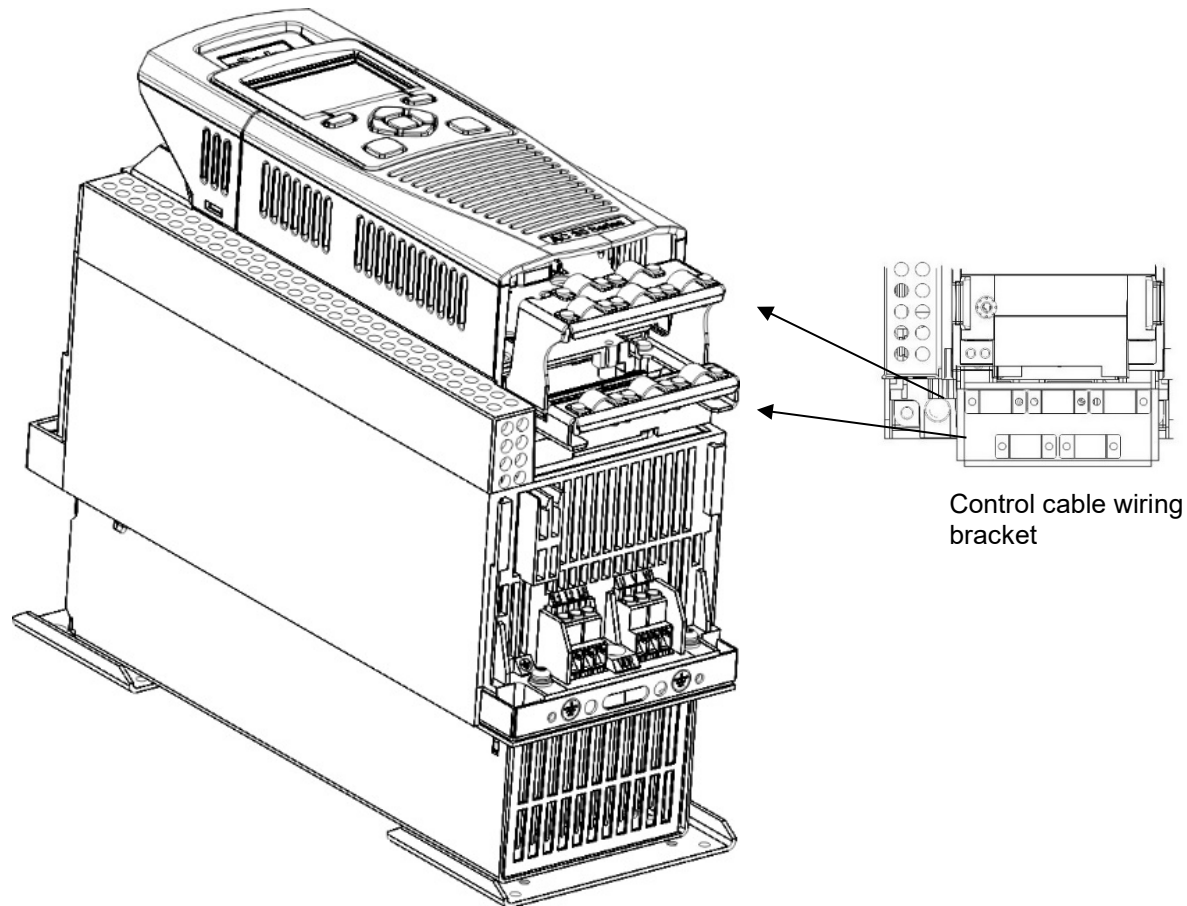

5-26 Installation - Control Module

ETHERNET COMMUNICATIONS CABLE

The inverter comes with built-in Ethernet providing communications with the PC programming tools PDQ and PDD, a Modbus TCP server and a web server.

The AC30V control module has one in-built Ethernet port, the AC30P/D/A have two.

HA503711U003 'Chapter 8: Ethernet' provides details on how to setup the Ethernet communications port.

Connecting the Ethernet Cable – AC30V

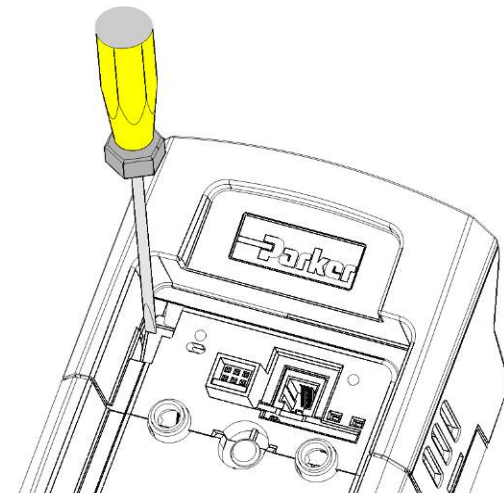
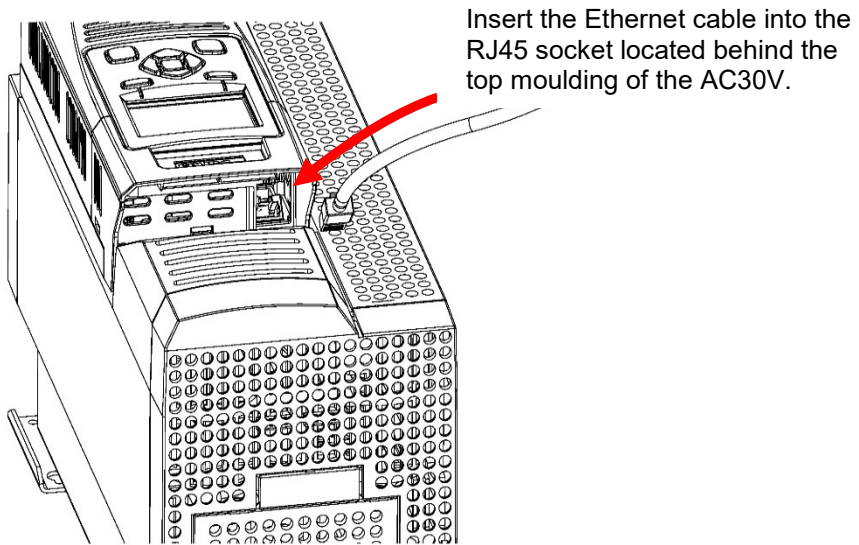

To remove the Ethernet cable:

1. Remove the GKP/Blanking Plate.
2. Insert a screwdriver into the hole in the moulding (as shown in the diagram) to release the tab on the Ethernet cable plug and pull the cable away.

Connecting the Ethernet Cables – AC30P/D/A

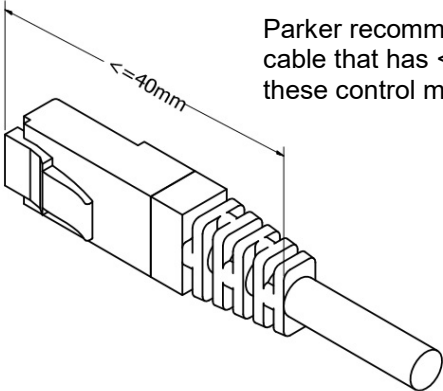
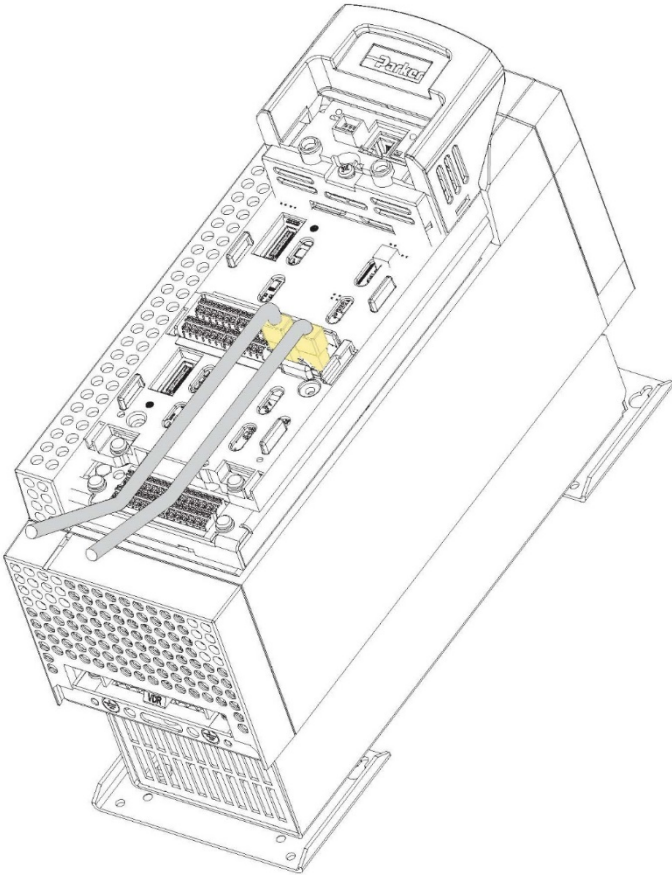

Parker recommend the use of an Ethernet cable that has $\leq 40\text{mm}$ body length, with these control module variants.

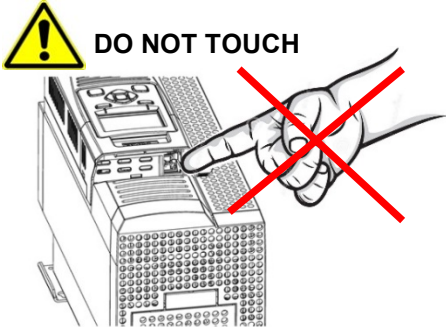

DO NOT TOUCH
DO NOT touch the board surface via the aperture shown

ETHERNET CABLE RECOMMENDATION

The following Ethernet cables are recommended for use with the AC30 series control modules:

Category	Screened?
CAT5e	Yes
CAT6	Yes

5-28 Installation - Control Module

OPTION & COMMUNICATION CARD INSTALLATION DETAILS (OPTIONAL)

The range of AC30 series Option and Communications cards are list in 'Chapter 7: Associated Equipment – Control Module' section.

To fit the cards:

1. Remove the GKP/Blanking Plate (if fitted) and Control Module Cover as instructed on page 5-3.
2. Click onto the control module casting either the Option card (top position) or Comms card (bottom position).
3. Tighten the Option/Comms card retaining screw to secure.
4. Refer to the Option/Comms card Manual Reference for wiring information.

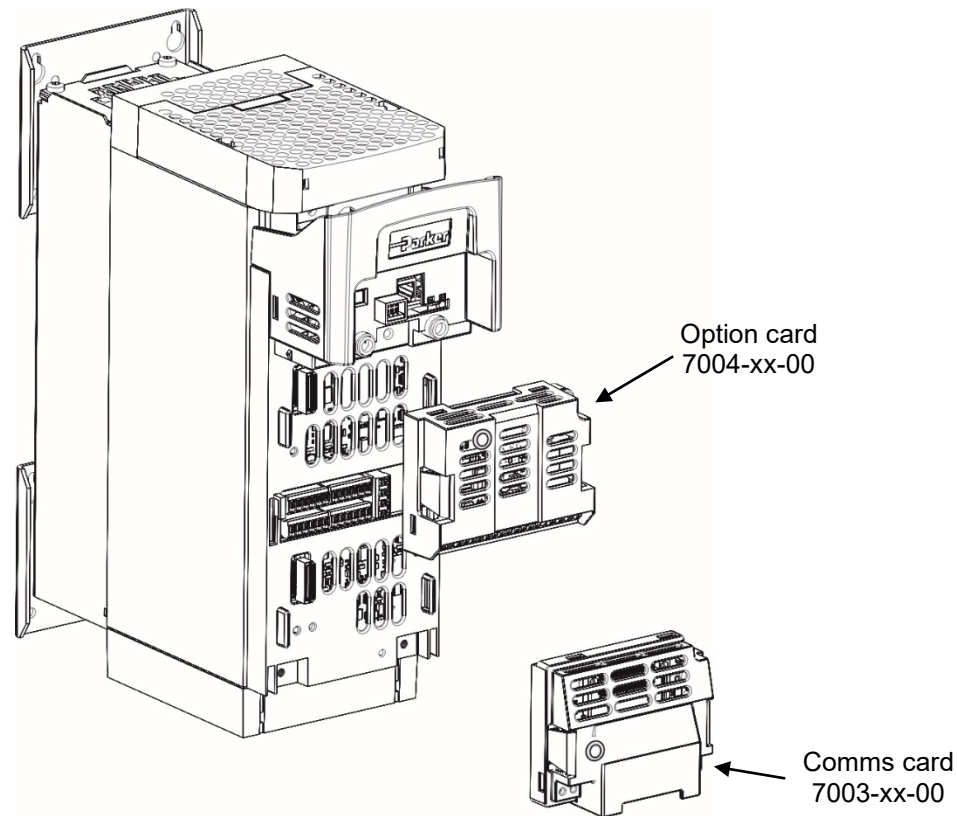

Installation - Control Module 5-29

To remove the cards:

1. Remove the GKP/Blanking Plate (if fitted) and Control Module Cover if required.
2. Untighten the Option/Comms card retaining screw.
3. Squeeze the sides of the Option/Comms card plastic moulding as shown in the diagram, and pull away from the control module casting.

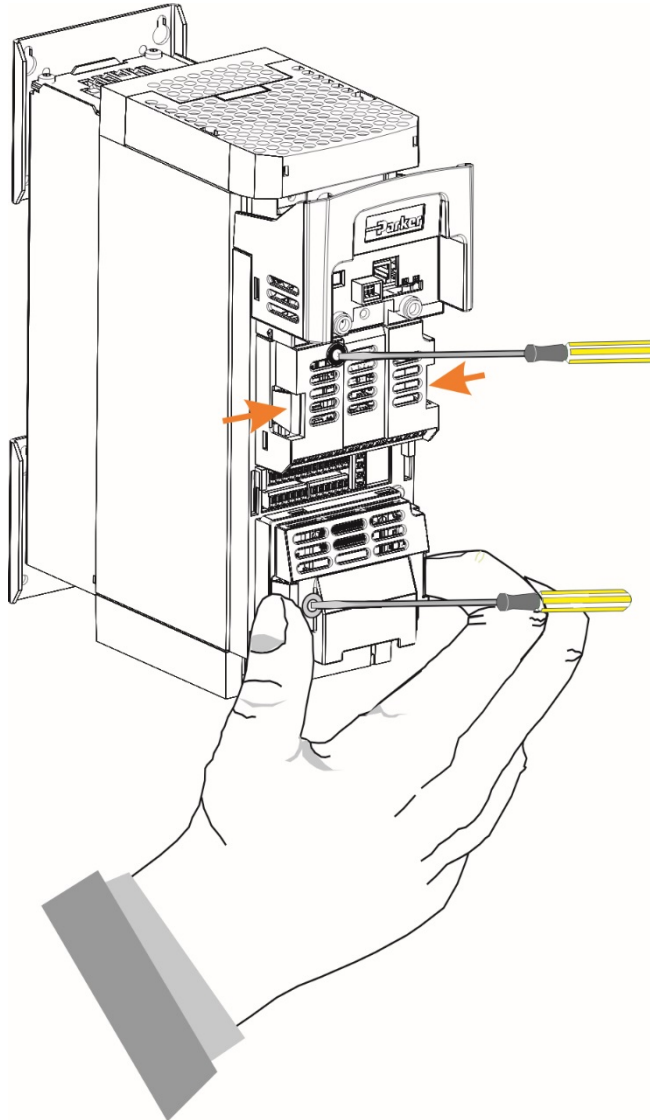

HAZARDOUS VOLTAGES may be present on the GPIO module motor thermistor user relays, please refer to the option technical manual or main product manual for safety information.

5-30 Installation - Control Module

SD CARD INSTALLATION

SD cards provide a means of updating product firmware, drive cloning and application backup and recovery. Parker recommended SD cards are listed in the 'Chapter 7: Associated Equipment – Control Module' section.

To fit the cards:

1. Remove the GKP/Blanking Plate (if fitted) as instructed on page 5-3.
2. With the SD card pointing label side down, insert the card into the slot in the control module top moulding. The card should 'click' when engaged.

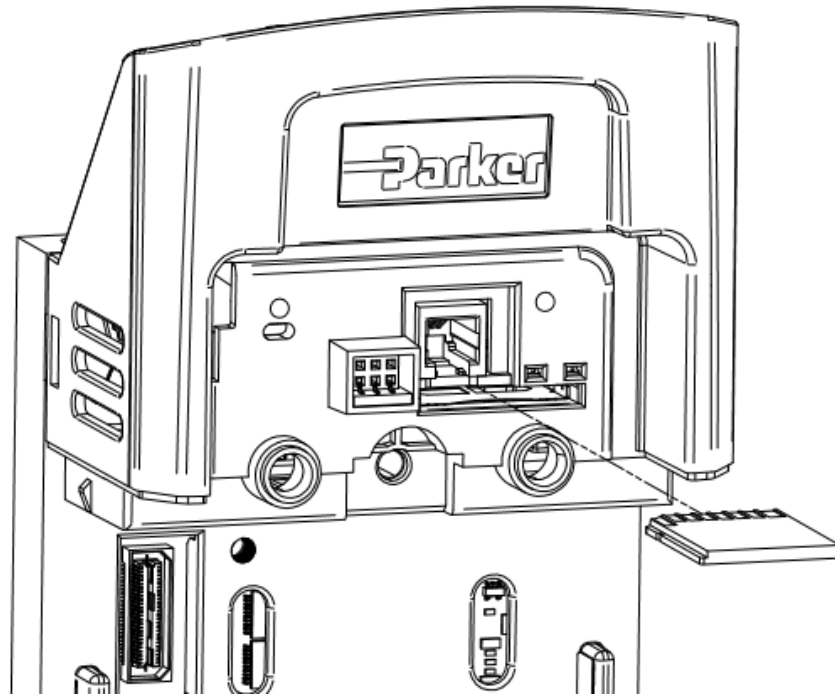

To remove the SD card:

1. Push the SD card down so that it 'clicks'.
2. It should now pop out from the slot, ready for removal.

Fitting a Remote GKP

It is possible to order an AC30 control module with either the Graphical Keypad (GKP) mounted on the front of the unit, or with a blanking plate fitted in its place.

Where a control module is not fitted with a GKP, one can be ordered separately through your local sales office.

Refer to 'Chapter 7: Associated Equipment – Control Module' for options.

When remote mounting the GKP to either a cubicle door or panel, it **must** be fitted onto a flat surface.

The cut-out details for doing so are given below:

GKP (Reverse side)

- The yellow dotted line is the cutout detail to allow remote fitting of the connection lead.
- 4x GKP fixings are M3 x 10 self tapping screws.
- Connection lead is a RS232/REM OP STA with a Steward 28A2025-OAO connector.

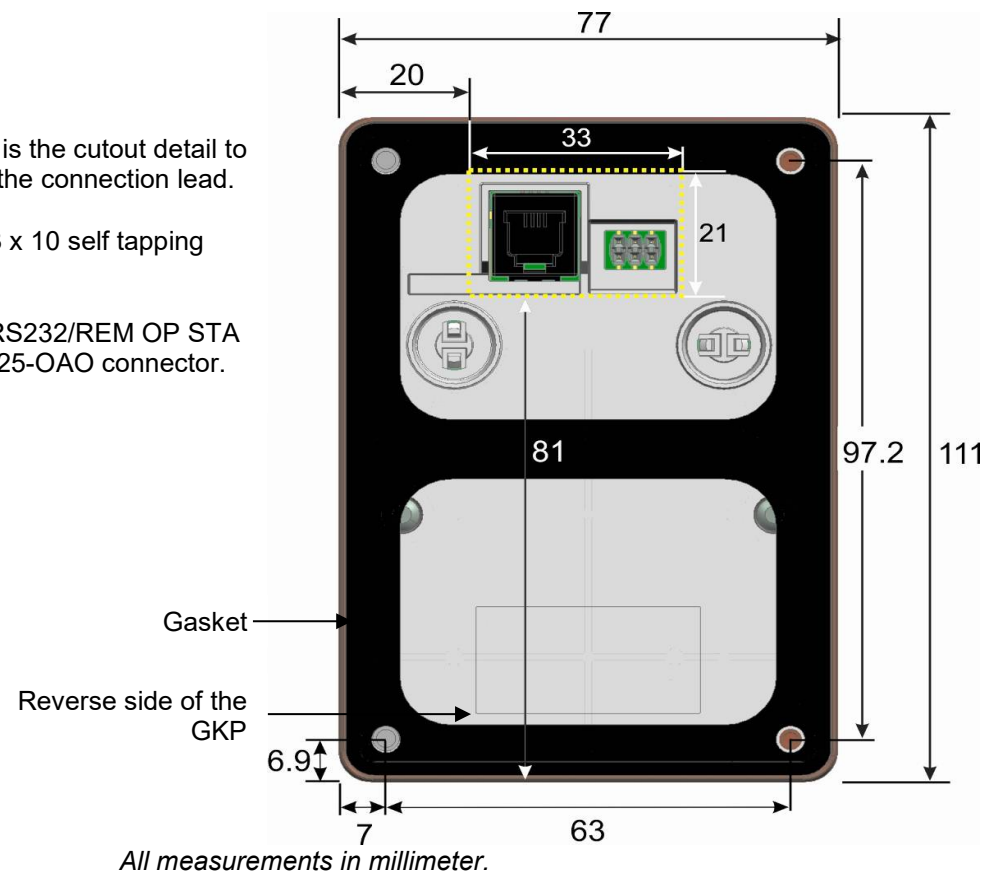

Note: The 3 m connection lead supplied by Parker is the maximum length that can be used.

5-32 Installation - Control Module

Chapter 6: Associated Equipment - Power Stack

AC LINE FED 710 STACKS: CONNECTION OVERVIEW

Connect the associated equipment to an AC Fed AC30 in the following order:

- A** AC Line Fuses
- B** EMC Filter (optional)
- C** AC Line Choke (optional)
- D** Dynamic Braking Resistor (optional)
- E** AC Motor Choke (optional)

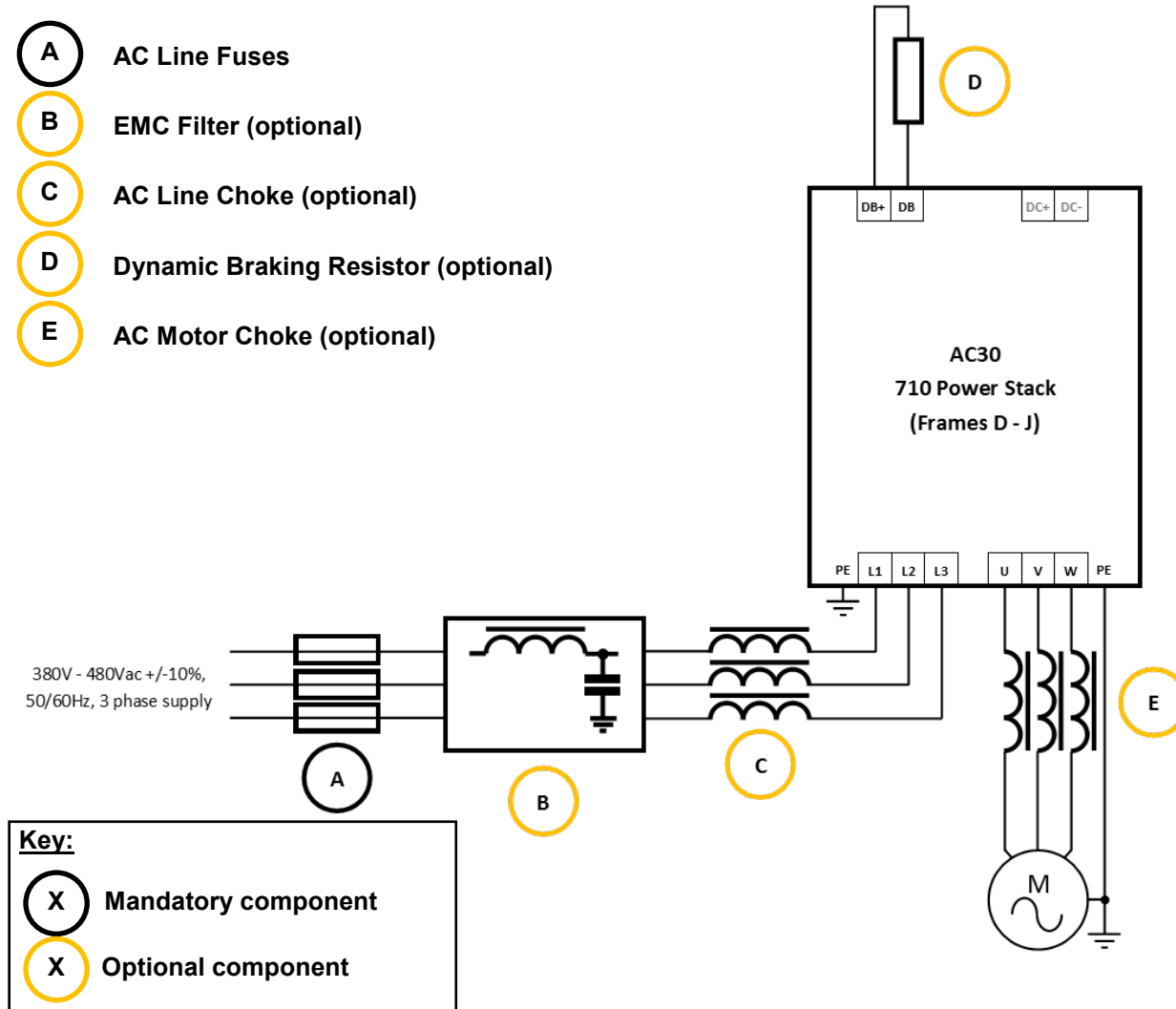

6-2 Associated Equipment - Power Stack

AC Line Input Fuses

Line input fuse ratings are given in the table below for both European and North American & Canada territories.

For North America, the recommended fuses are Mersen A60Q series, 600Vac/dc semiconductor protection fuses (Frames D & E), and Mersen A50QS series, 500Vac/dc semiconductor protection fuses (Frames F – J). These series are both UL recognised components.

These fuses are suitable for use on supplies delivering up to 100kA RMS symmetrical Amperes, 480V maximum.

Input bridge I²T values have been provided in the table to allow customers to source equivalent fuses for use in their installations.

Frame Size	Product Code	Input Bridge I ² T (A ² s) T _j @25°C	Europe	North America & Canada	
			Input Fuse Rating (A)	Input Fuse Rating (A)	Fuse Type
D	7x0-4D0004...	240	10	6	A60Q series
	7x0-4D0006...	240	10	10	A60Q series
	7x0-4D0010...	242	12	15	A60Q series
	7x0-4D0012...	242	16	20	A60Q series
E	7x0-4E0016...	685	20	25	A60Q series
	7x0-4E0023...	685	25	30	A60Q series
F	7x0-4F0032...	2,400	32	40	A50QS series
	7x0-4F0038...	2,400	40	50	A50QS series
	7x0-4F0045...	5,000	63	60	A50QS series
G	7x0-4G0045...	5,500	63	60	A50QS series
	7x0-4G0060...	5,500	80	80	A50QS series
	7x0-4G0073...	7,800	100	100	A50QS series
H	7x0-4H0087...	20,000	125	125	A50QS series
	7x0-4H0105...	20,000	150	150	A50QS series
	7x0-4H0145...	145,000	200	200	A50QS series
J	7x0-4J0180...	145,000	250	250	A50QS series
	7x0-4J0205...	145,000	315	300	A50QS series
	7x0-4J0260...	320,000	400	350	A50QS series

A60Q series fuses - Size 10x38.

The UL listed class J Mersen AJT series fuses can also be used for Frames D - G. This type of fuse is a non-renewable cartridge fuse (JDDZ), but renewable cartridge fuses (JDRX) can also be used.

Circuit Breakers (alternative to AC Line Fuses)

We do not recommend the use of circuit breakers (e.g. RCD, ELCB, GFCI), but where their use is mandatory, they should:

- Operate correctly with dc and ac protective earth currents (i.e. type B RCDs as in Amendment 2 of IEC755).
- Have adjustable trip amplitude and time characteristics to prevent nuisance tripping on switch-on.

When the ac supply is switched on, a pulse of current flows to earth to charge the internal/external ac supply EMC filter's internal capacitors which are connected between phase and earth. This has been minimised in Parker inverter filters, but may still trip out any circuit breaker in the earth system. In addition, high frequency and dc components of earth leakage currents will flow under normal operating conditions. Under certain fault conditions larger dc protective earth currents may flow. The protective function of some circuit breakers cannot be guaranteed under such operating conditions.



WARNING

Circuit breakers used with VSDs and other similar equipment are not suitable for personnel protection. Use other means to provide personal safety. Refer to EN50178 / VDE0160 / EN60204-1.



6-4 Associated Equipment - Power Stack

External EMC Filters (optional)

Additional external EMC filters are sometimes required to meet specific conducted emissions standards and environments. Parker recommend the following external EMC filters for use with the AC30 power stacks:

Frame Size	Product Code	Motor Power		Rated Voltage (V)	Rated Current (A)	Supply Earthing Scheme	Parker Part Number
		kW	hp				
D	7x0-4D0004...	1.1	1.5	3 phase, 500V	36	IT & TN	CO501894
	7x0-4D0006...	2.2	3				
	7x0-4D0010...	4	5				
	7x0-4D0012...	5.5	7.5				
E	7x0-4E0016...	7.5	10	3 phase, 500V	36	IT & TN	CO501894
	7x0-4E0023...	11	15				
F	7x0-4F0032...	15	20	3 phase, 500V	50	IT & TN	CO501895
	7x0-4F0038...	18.5	25				
	7x0-4F0045...	22	30				
G	7x0-4G0045...	22	30	3 phase, 500V	150	IT & TN	CO502672U150
	7x0-4G0060...	30	40				
	7x0-4G0073...	37	50				
H	7x0-4H0087...	45	60	3 phase, 500V	150	IT & TN	CO502672U150
	7x0-4H0105...	55	75				
	7x0-4H0145...	75	100				
J	7x0-4J0180...	90	125	3 phase, 500V	320	IT & TN	CO502672U320
	7x0-4J0205...	110	150				
	7x0-4J0260...	132	200				

Refer to 'Appendix A: Compliance' for further information on when an external EMC filter is to be used, as well as EMC advice to consider during the product installation.

AC Line Chokes (optional)

AC30 frames D – J have an internal DC link choke, with the exception of the 710-4D0004... & 710-4D0006... products. However, in some instances an external AC line choke may also be required:

1. Frames D, E, & F: when used on supplies delivering more than 5kA but less than 50kA RMS symmetrical Amperes, 480V maximum.
2. Frames G, H & J: when used on supplies delivering more than 10kA but less than 50kA RMS symmetrical Amperes, 480V maximum.
3. when used to mitigate supply quality issues.

Parker recommend the following AC line chokes for use with 710 stacks:

Frame Size	Product Code	Motor Power		Inductance (mH)	Rated Current (A)	Parker Part Number
		kW	hp			
D	710-4D0004...	1.1	1.5	6.5	4	CO470651
	710-4D0006...	2.2	3	5	8	CO352782
	710-4D0010...	4	5	3	8	CO470652
	710-4D0012...	5.5	7.5	2.5	12	CO352783
E	710-4E0016...	7.5	10	1.5	18	CO352785
	710-4E0023...	11	15	1.2	25	CO352786
F	710-4F0032...	15	20	0.8	35	CO352901
	710-4F0038...	18.5	25	0.8	35	CO352901
	710-4F0045...	22	30	0.7	45	CO352902
G	710-4G0045...	22	30	0.7	45	CO352902
	710-4G0060...	30	40	0.5	55	CO352903
	710-4G0073...	37	50	0.4	80	CO352904
H	710-4H0087...	45	60	0.4	80	CO352904
	710-4H0105...	55	75	0.3	100	CO352905
	710-4H0145...	75	100	0.2	130	CO352906
J	710-4J0180...	90	125	0.15	160	CO470057
	710-4J0205...	110	150	0.11	200	CO470045
	710-4J0260...	132	200	0.09	250	CO470046

6-6 Associated Equipment - Power Stack

Dynamic Braking Resistors (optional)

Dynamic Brake Resistors tend to be used when an application requires regenerated power from the motor to be dissipated. The AC30 Frames D - J are all fitted with an internal brake switch as standard, ready for connection to an external Dynamic Brake Resistor.

Systems applications that have a number of inverters connected on a common DC bus, either from a regenerative DC supply unit or as part of an AFE system, may not require the use of braking resistors.

Where a Dynamic Brake Resistor is used, Parker recommend the addition of a thermal overload switch to be fitted in series with the resistor, in order to protect the component.

Calculation

The Dynamic Brake Resistor must be rated to absorb both peak braking power during deceleration, as well as the average power over the complete cycle. The following formulas can be used to calculate the peak and average braking power:

Peak Braking Power

$$P_{pk} (W) = \frac{0.0055 \times J \times (n_1^2 - n_2^2)}{t_b}$$

Where:

J = total inertia (kgm²)

n₁ = initial speed (rpm)

n₂ = final speed (rpm)

t_b = braking time (s)

t_c = cycle time (s)

Average Braking Power

$$P_{av} (W) = \frac{P_{pk}}{t_c} \times t_b$$

Once the peak and average braking power of the application is calculated, an appropriately rated resistor will need to be selected. Refer to 'Appendix E: Technical Specifications – Power Stack' for minimum resistor values that can be used with each power stack.

It is recommended that a large safety margin must be incorporated to ensure that the resistors are not overloaded.

Resistor Selection

Parker recommend a limited range of small metal-clad resistors for use with the smaller frame sizes.

By connecting resistors in series/parallel, it should be possible to achieve the required resistor values and power rating.

These should be mounted on either a heatsink or on the cubicle back panel.



ATTENTION

These resistors get extremely hot, so it is important to ensure that they are guarded and cooled appropriately to prevent injury from burning.

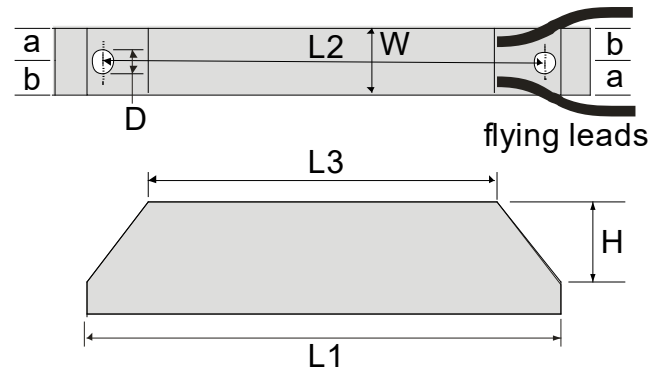

Parker Part Number	Power Rating (W)	Resistance (Ω)	Continuous Current Rating (A)	Dimensions (mm)								
				L1	L2	L3	a	b	D	W	H	Flying Leads
CZ467717	200	100	1.4	165	146	125	13	17	5.3	60	30	500
CZ463068	200	56	1.9	165	146	125	13	17	5.3	60	30	500
CZ467716	500	56	3.0	335	316	295	13	17	5.3	60	30	500
CZ388396	500	36	3.7	335	316	295	13	17	5.3	60	30	500

Refer to 'Chapter 4: Installation – Power Stack' for details on how to connect up the DBR to the inverter.

For the larger inverters, contact a brake resistor manufacturer with the peak and average power requirements, in addition to the minimum resistor value specified.

6-8 Associated Equipment - Power Stack

AC Motor Chokes (optional)

The maximum rate of rise of Volts (dv/dt) present at the inverter output can be as high as 10,000V/ μ s.

Adding an output choke between the inverter and motor reduces the dv/dt and peak voltage present at the motor which in turn reduces the stress applied to the motor insulation.

Installations with long cable runs may also suffer from nuisance overcurrent trips. An output choke may be fitted in the inverter output to limit parasitic capacitive current flowing to earth.

Refer to 'Appendix A: Compliance' for maximum motor cable lengths.

Where required, Parker recommend the following output choke ratings:

Frame Size	Product Code	Motor Power		Inductance (mH)	Rated Current (A)	Parker Part Number
		kW	hp			
D	7x0-4D0004...	1.1	1.5	2	7.5	CO055931
	7x0-4D0006...	2.2	3	2	7.5	CO055931
	7x0-4D0010...	4	5	0.9	22	CO057283
	7x0-4D0012...	5.5	7.5	0.9	22	CO057283
E	7x0-4E0016...	7.5	10	0.9	22	CO057283
	7x0-4E0023...	11	15	0.45	33	CO057284
F	7x0-4F0032...	15	20	0.45	33	CO057284
	7x0-4F0038...	18.5	25	0.3	44	CO057285
	7x0-4F0045...	22	30	0.05	70	CO055193
G	7x0-4G0045...	22	30	0.05	70	CO055193
	7x0-4G0060...	30	40	0.05	70	CO055193
	7x0-4G0073...	37	50	0.05	99	CO055253
H	7x0-4H0087...	45	60	0.05	99	CO055253
	7x0-4H0105...	55	75	0.05	243	CO057960
	7x0-4H0145...	75	100	0.05	360	CO387886
J	710-4J0180...	90	125	0.05	360	CO387886
	710-4J0205...	110	150	0.05	360	CO387886
	710-4J0260...	132	200	0.05	360	CO387886

DC LINK FED 740 STACKS: CONNECTION OVERVIEW

An example of how to connect AC30 DC Link Fed drives in a system configuration is shown below:

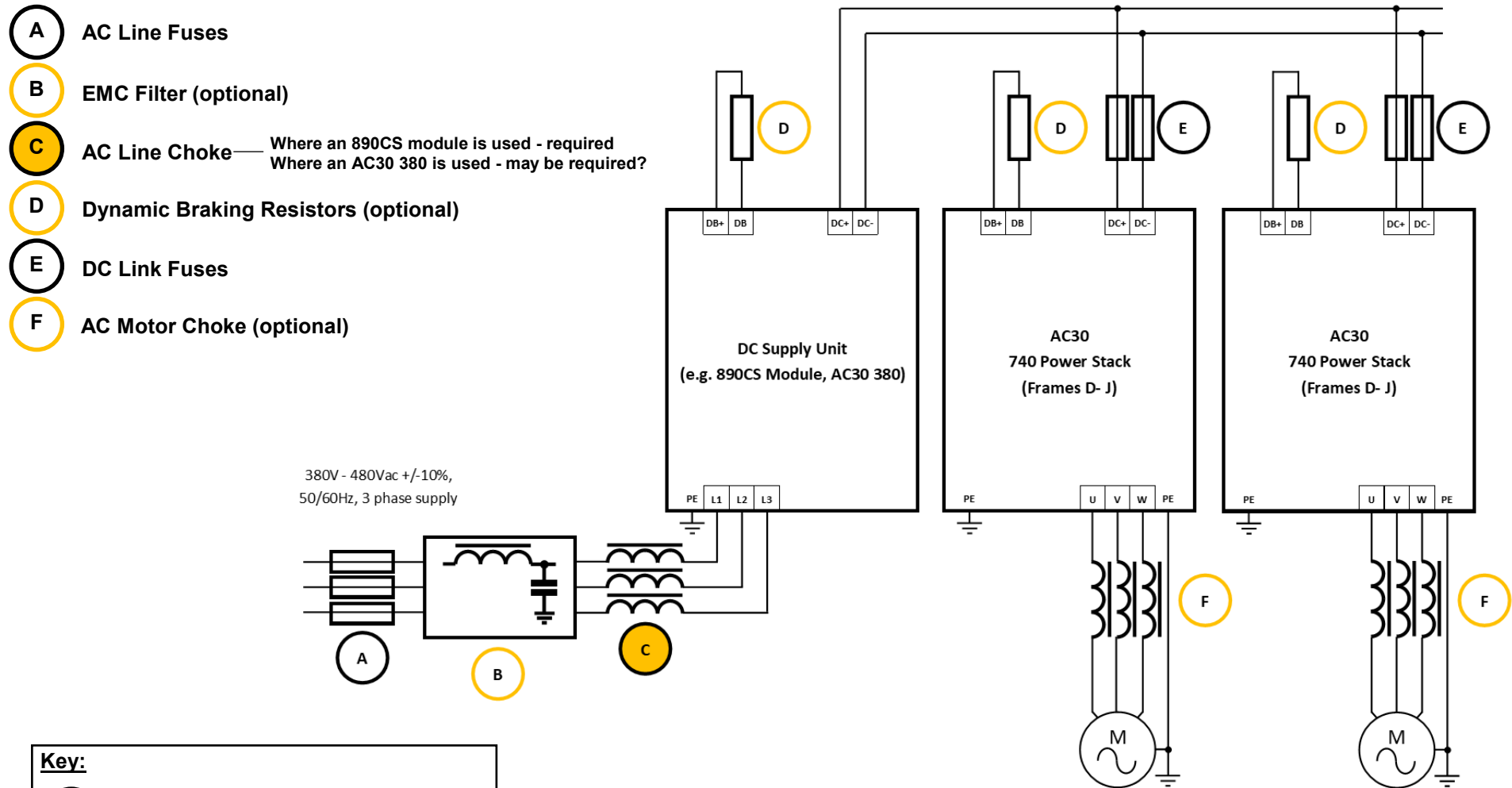

- (A)** AC Line Fuses
- (B)** EMC Filter (optional)
- (C)** AC Line Choke — Where an 890CS module is used - required
Where an AC30 380 is used - may be required?
- (D)** Dynamic Braking Resistors (optional)
- (E)** DC Link Fuses
- (F)** AC Motor Choke (optional)

Key:

- (X)** Mandatory component
- (X)** Optional component
- (X)** Component may be required?

6-10 Associated Equipment - Power Stack

AC Line Input Fuses

Refer to the installation manual of the DC supply unit.

External EMC Filters (optional)

Refer to the installation manual of the DC supply unit.

AC Line Choke

The DC supply unit may have minimum inductance requirements to satisfy (e.g., 3% for 890CS), or it may include an internal line choke (e.g., AC30 regenerative DC supply unit 380-5xxxx...).

If an external AC line choke is required, then the inductance value is determined by the sum of the motor currents attached to the associated output stages and supply voltage.

For example:

If a 7.5kW, 4 pole, 400VAC motor has a FLC of 14A,

If a 22kW, 4 pole, 400VAC motor has a FLC of 45A,

If a 37kW, 4 pole, 400VAC motor has a FLC of 66A,

Then a system with 4x 7.5kW motors, 2x 22kW and 1x 37kW has a total current of 212A.

If it is known that one of the 22kW motors is overhauled during normal operation, then that motor current can be subtracted from and not added to the total load current. In this case, the total load current would be reduced to 122A.

The value of the AC line choke is then calculated using the following formula:

Inductance per phase

$$L_{\text{phase}} \text{ (H)} = \frac{V_{\text{line-to-line}}}{272 \times I_{\text{total}} \times f}$$

Where:

$V_{\text{line-to-line}}$ = RMS line-to-line supply voltage (V)

I_{total} = Total load current (A)

f = supply frequency (Hz)

Pre-charge Considerations

The AC30 regenerative DC supply unit (380-5xxxx...) is required to pre-charge the DC bus capacitance at power up. The 380-5xxxx... internal pre-charge circuitry should be rated (in terms of peak power and impulse energy) to charge the total DC bus capacitance, and should be rated to carry 45W to the internal power supply of each drive, without dropping more than 40V.

The total system DC bus capacitance is the sum of the internal DC bus capacitance of each drive supplied from the DC supply unit.

The internal capacitance for each drive power rating (Frames D - J) is provided in the table below:

Frame Size	Product Code	Internal Capacitance
D	7x0-4D0004	340 μ F
	7x0-4D0006	340 μ F
	7x0-4D0010	340 μ F
	7x0-4D0012	340 μ F
E	7x0-4E0016	500 μ F
	7x0-4E0023	700 μ F
F	7x0-4F0032	1000 μ F
	7x0-4F0038	1400 μ F
	7x0-4F0045	1400 μ F
G	7x0-4G0045	1800 μ F
	7x0-4G0060	2300 μ F
	7x0-4G0073	2800 μ F
H	7x0-4H0087	3600 μ F
	7x0-4H0105	4200 μ F
	7x0-4H0145	5600 μ F
J	7x0-4J0180	6600 μ F
	7x0-4J0205	8400 μ F
	7x0-4J0260	9900 μ F

Note: The 890CS module does not have an internal pre-charge resistor and does not require an external one.

Dynamic Braking Resistors (optional)

See page 6-7.

6-12 Associated Equipment - Power Stack

DC Link Input Fuses

DC link input fuse ratings are given in the table below for both European and North American territories.

For North America, the recommended fuses are Mersen A70QS series, 700Vac/dc semiconductor protection fuses. These are UL recognised components.

Customers can source equivalent fuses for use in their installations.

Note: Where inverters are used on AFE systems with elevated DC link buses above 700V, higher voltage fuses must be used.

Frame Size	Product Code	Europe	North America & Canada	
		Input Fuse Rating (A)	Input Fuse Rating (A)	Fuse Type
D	740-4D0004...	10	10	A70QS series
	740-4D0006...	16	15	A70QS series
	740-4D0010...	20	15	A70QS series
	740-4D0012...	20	20	A70QS series
E	740-4E0016...	32	32	A70QS series
	740-4E0023...	40	35	A70QS series
F	740-4F0032...	50	50	A70QS series
	740-4F0038...	50	60	A70QS series
	740-4F0045...	70	70	A70QS series
G	740-4G0045...	70	70	A70QS series
	740-4G0060...	100	100	A70QS series
	740-4G0073...	100	125	A70QS series
H	740-4H0087...	150	150	A70QS series
	740-4H0105...	175	175	A70QS series
	740-4H0145...	200	200	A70QS series
J	740-4J0180...	315	300	A70QS series
	740-4J0205...	400	350	A70QS series
	740-4J0260...	400	400	A70QS series

A70QS series - Size 14x51 fuses available 10-50A, Size 22x58 fuses available 10-100A, Standard series fuse available 35-400A

AC Motor Chokes

See page 6-8.

AFE SYSTEM: CONNECTION OVERVIEW

An example of how to connect AC30 DC Link Fed drives in an AFE system configuration is shown below:

Note: VDR & Y-Cap disconnects need to be removed from ALL drives. See 'Chapter 4: Installation - Power Stack' section for details.

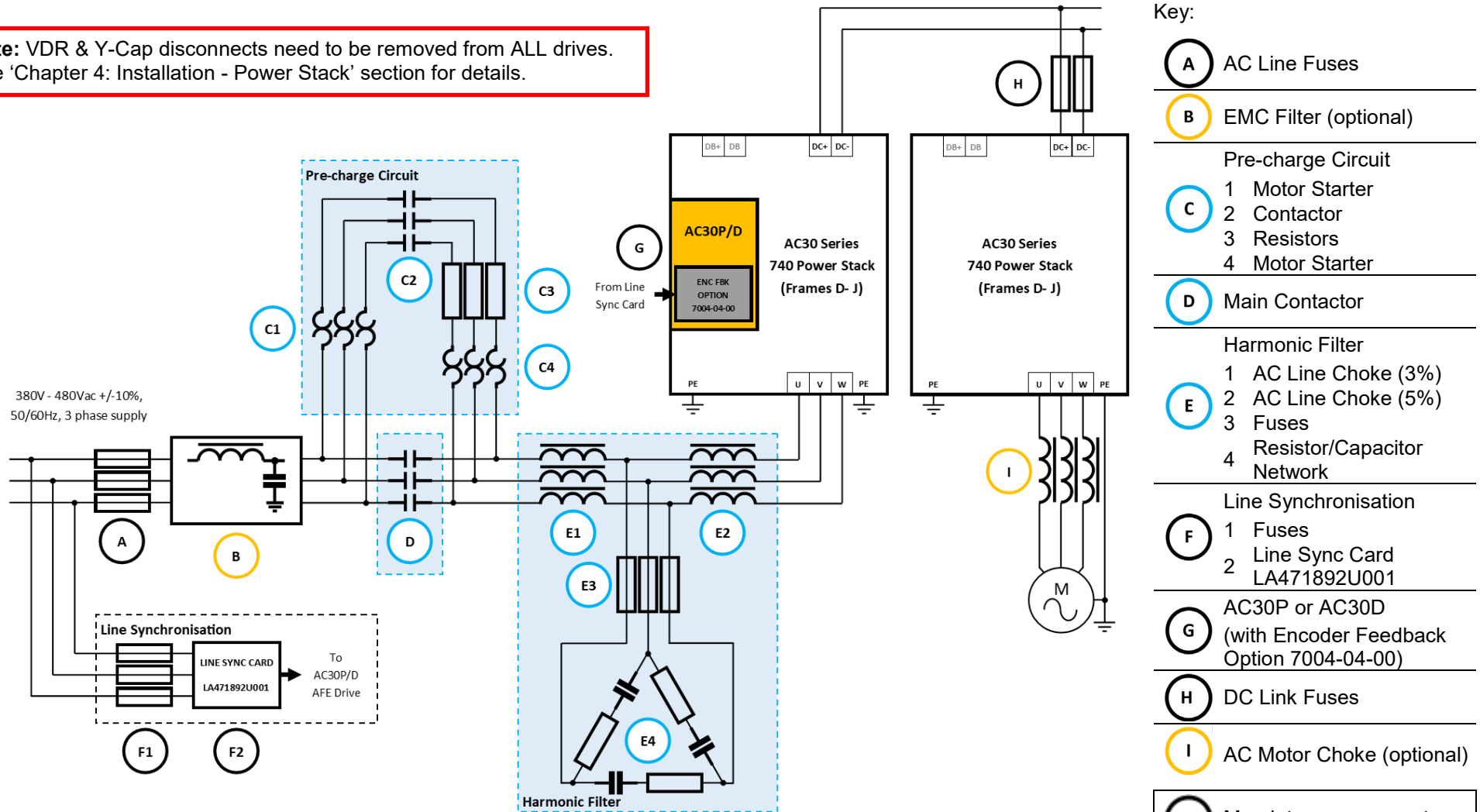

Key:

- A AC Line Fuses

- B EMC Filter (optional)

- C Pre-charge Circuit
 - 1 Motor Starter
 - 2 Contactor
 - 3 Resistors
 - 4 Motor Starter

- D Main Contactor

- E Harmonic Filter
 - 1 AC Line Choke (3%)
 - 2 AC Line Choke (5%)
 - 3 Fuses
 - 4 Resistor/Capacitor Network

- F Line Synchronisation
 - 1 Fuses
 - 2 Line Sync Card LA471892U001

- G AC30P or AC30D (with Encoder Feedback Option 7004-04-00)

- H DC Link Fuses

- I AC Motor Choke (optional)

- X Mandatory component
- X Optional component
- X System component (not addressed in this Manual)

AFE control sequence:

The default AFE macro in the AC30 - 'App_5_AFE Control' should be setup to perform this automated sequence:

1. Close the pre-charge contactor (C2) and charge the DC bus up to a minimum 340V level.
 2. Close the main contactor (D).
 3. With the main contactor (D) closed, synchronise the drive with the mains supply frequency.
 4. When the inverter is enabled, the AFE will now be in operation with the DC link voltage boosted above the peak of the mains voltage.
- See HA503711U003 'Appendix C: Parameter Reference' for details.

6-14 Associated Equipment - Power Stack

AC Line Input Fuses

See page 6-2.

External EMC Filters (optional)

See page 6-4.

DC Link Input Fuses

See page 6-12.

AC Motor Chokes

See page 6-8.

Line Synchronisation Card & AC30 Control Module

The control module required for AFE functionality with an AC30 power stack must be either an AC30P or AC30D fitted with the Encoder Feedback option module 7004-04-00.

The AC30V does not have AFE control capability.

The Line Synchronisation Card LA471892U001 is connected up to the Encoder Feedback option as shown below:

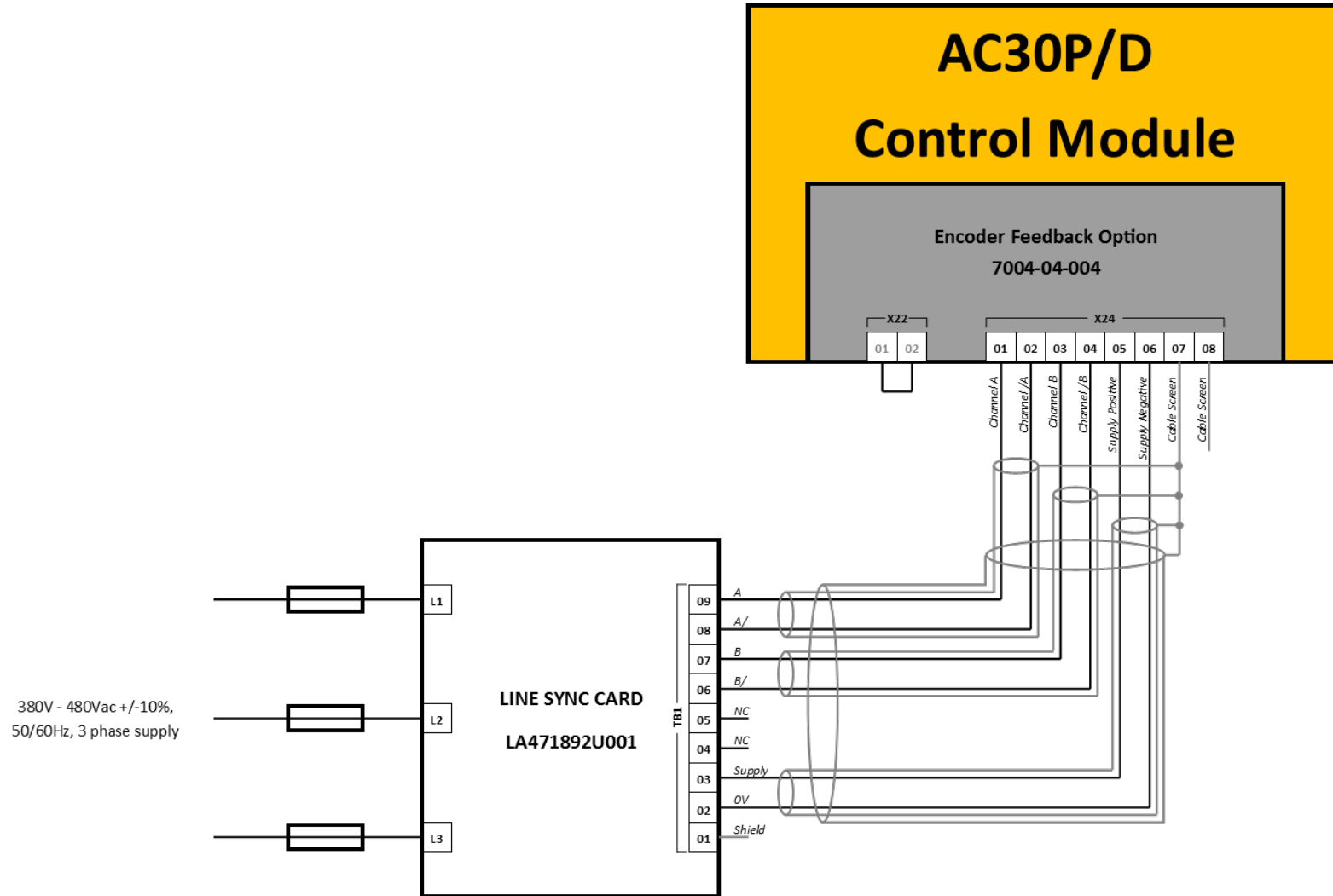

6-16 Associated Equipment - Power Stack

ADDITIONAL ACCESSORIES

Gasket Kits

Gasket kits can be purchased from Parker for use when through panel mounting the drive.
The IP55 through panel kits include IP55 fans. The IP20 kits do not.

Frame Size	Product Code	Through Panel Gasket Kit Part Number	
		IP20	IP55 (with IP55 fan included)
D	740-4D0004...	LA502668-1	LA503104U001-1
	740-4D0006...		
	740-4D0010...		
	740-4D0012...		
E	740-4E0016...	LA502669-1	LA503104U002-1
	740-4E0023...		
F	740-4F0032...	LA502670-1	LA503104U003-1
	740-4F0038...		
	740-4F0045...		
G	740-4G0045...	LA502471-1	LA503104U014-1
	740-4G0060...		LA503104U004-1
	740-4G0073...		LA503104U004-1
H	740-4H0087...	LA502472-1	LA503104U015-1
	740-4H0105...		LA503104U005-1
	740-4H0145...		LA503104U005-1
J	740-4J0180...	LA502793-1	LA503104U006-1
	740-4J0205...		
	740-4J0260...		

For installation information see 'Chapter 4: Installation – Power Stack'.

Cabling Brackets

The following AC30 series power stack cabling brackets are also available and come inclusive of the AC30V/P control module bracket:

Frame Size	Cabling Bracket Kit Part Number	
	Panel Mount	Through Panel
D	LA501935U001-1*	LA503117U001-1*
E	LA501935U002-1*	LA503117U002-1*
F	LA501935U003-1*	LA503117U003-1*
G	LA501935U004-1	LA503117U004-1
H	LA501935U005-1	LA503117U005-1
J	LA501935U006-1	Not available

* = Kit includes output ringcore.

When kit (including ringcore) is added to a 710-4xxxxx-xE... C3 filtered product, it becomes a 710-4xxxxx-xF... C2 filtered product.

For installation information see 'Chapter 4: Installation – Power Stack'.

For further information about conducted emissions limits and solutions, see 'Appendix A: Compliance'.

Vibration Mounts (For Marine Applications)

The following AC30 series vibration mounting kits are available for compliance with Det Norske Veritas' (DNV GL) Rules for Classification of Ships, Offshore Units, and High Speed & Light Craft:

Frame Size	Vibration Mounting Kit Part Number
D	LA503058U001-1
E	
F	
G	LA503058U002-1
H	LA503058U003-1

For installation information see 'Chapter 4: Installation – Power Stack'.

For further information about the vibration limits, see 'Appendix A: Compliance'.

6-18 Associated Equipment - Power Stack

Chapter 7: Associated Equipment - Control Module

Cabling Brackets

The following AC30 series control module cabling bracket kits are available from Parker:

AC30 Control Module	Cabling Bracket Kit Part Number
AC30V/P	LA501772U001-1*
AC30D/A	LA501935U007-1†

* = If a power stack cabling bracket kit is purchased for Frames D-J, the kit comes inclusive of the AC30V/P control module cabling bracket. See HA503711U001 'Chapter 6: Associated Equipment – Power Stack' for part numbers.

† = For the AC30D & AC30A, the cable bracket must be fitted in order to meet EMC compliance.

The alternative to this solution, is for the user to provide a local earth bracket for the feedback cable screen connection, as well as a means of guarding the user terminals.

For installation information see 'Chapter 5: Installation – Control Module'.

Option Cards

There are a range of Option Cards that are available for customer fitting to an AC30 series control module:

Product Code	Description	Manual Reference
7004-01-00	General Purpose I/O Option (GPIO): - Digital Inputs/Outputs (x4) - Analogue Inputs (x3) - Motor Thermistor (x1) - Volt-free Relay Outputs (x2) - Real-Time Clock	HA501836U001
7004-02-00	Thermistor Option: - Motor Thermistor Input (x1)	HA501836U001
7004-04-00	Pulse Encoder Feedback Option: - Thermistor input (x1)	HA502217U001
7004-05-00	Resolver Feedback Option: - Thermistor input (x1)	HA503540U001

Refer to the Technical Manual for detailed instructions.

For installation information see 'Chapter 5: Installation – Control Module'.

7-2 Associated Equipment - Control Module

Communication Cards

There are a range of Communication Cards that are available for customer fitting to an AC30 series control module:

Product Code	Comms Protocol	Manual Reference
7003-PB-00	Profibus DP-V1	HA501837U001
7003-PN-00	PROFINET IO	HA501838U001
7003-CB-00	CANopen	HA501841U001
7003-IP-00	EtherNet IP	HA501842U001
7003-EC-00	EtherCAT	HA501938U001
7003-RS-00	Modbus RTU	HA501839U001

Refer to the Technical Manual for detailed instructions.

For installation information see 'Chapter 5: Installation – Control Module'.

SD Memory Cards

Parker have validated the following SD card for use with the AC30 control modules:

Manufacturer	Part No.	Description
Cactus	KS1GRT-806	SD Memory Card, 1GB

Other brands vary in performance and may have some compatibility issues in certain operating modes of the AC30.

For installation information see 'Chapter 5: Installation – Control Module'.

Graphical Keypad (GKP)

Where a control module is not fitted with a GKP, one can be ordered separately through your local sales office:

Product Code	Description
7001-00-00	Graphical Keypad (GKP)
7001-00-01	Graphical Keypad (GKP), inc. remote mounting assembly kit LA501991U300

The remote mounting assembly kit can be ordered separately:

Product Code	Description
LA501991U300-1	GKP remote mounting assembly kit inc.: <ul style="list-style-type: none"> - 3m connection lead - 4x screws

For installation information see 'Chapter 5: Installation – Control Module'.

7-4 Associated Equipment - Control Module

Chapter 8: Safe Torque Off SIL3/PLe

General Information



THIS EQUIPMENT IF USED INCORRECTLY IS POTENTIALLY DANGEROUS. THEREFORE UNDER NO CIRCUMSTANCES SHOULD IT BE USED BEFORE THESE INSTRUCTIONS HAVE BEEN READ AND UNDERSTOOD BY THE END USER WHO SHOULD BE APPROPRIATELY QUALIFIED TO OPERATE THE EQUIPMENT.

This section provides general information about Safe Torque Off (STO).

Two safety functions can be implemented with the inverter: STO and Safe Stop 1 (SS1). In order to meet all aspects of STO and SS1, an external safety control unit should be used.

To implement Safe Stop 1 (SS1), the external safety control unit causes the drive to decelerate to rest. Once at rest, it invokes STO in the inverter.

Please refer to EN61800-5-2:2007 para 4.2.2.3 for the formal definitions.

It is the user's responsibility to:

- 1) Risk assess the machine.
- 2) Design, implement and assess an appropriate solution for each application to meet all relevant safety requirements.

Note: STO is an electronic inhibit intended for use during normal operation of the machine. It is not intended for use during machine maintenance, repair, replacement or other similar activities. For these activities recognised electrical power isolation devices and lock-off procedures should be used. The inverter STO function is a factory-fitted and factory-tested feature. See the section "Safety Warnings and Limitations" on page 8-17.

8-2 Safe Torque Off

STO Functional Description

STO is a means of preventing an inverter from delivering rotational force to its connected electric motor. Please refer to EN61800-5-2:2007 para 4.2.2.2 for the formal definition.

To ensure a high degree of safety, two independent STO control channels are implemented in hardware. The STO circuit in the inverter is designed such that a fault in one control channel will not affect the other channel's ability to prevent the drive from starting, i.e. the STO function of the inverter is tolerant to any single fault. It may not be tolerant to an accumulation of faults. This is in keeping with its declared safety ratings.

STO always overrides any attempt to start the drive. If one or both STO control inputs is requesting the STO function, the drive will not start, even if for example, the drive's software malfunctions and tries to cause the motor to turn.

The STO function is implemented in hardware; it overrides all software activities. The only software involvement is to report STO status to the user via a Graphical Keypad (GKP), serial communications link or user terminal as defined by the drive configuration.



WARNING

THE DECLARED SIL/PL CAPABILITY OF THIS STO PRODUCT CAN BE ACHIEVED ONLY WHEN THE TWO STO USER INPUTS ARE DRIVEN INDEPENDENTLY. THEY MUST NOT BOTH BE DRIVEN FROM A COMMON SOURCE; OTHERWISE THE SINGLE FAULT DETECTION WILL BE COMPLETELY INOPERATIVE.
USE OF THE PRODUCT IN THIS "COMMON SOURCE" CONDITION INVALIDATES THE STO PRODUCT SPECIFICATION AND IS ENTIRELY AT THE USER'S OWN RISK.

Alignment to European Standards

EN ISO13849-1:2008

(Safety of machinery – Safety-related parts of control systems)

STO aligns internally to the following aspects of this standard:

- Architecture according to Category 3:

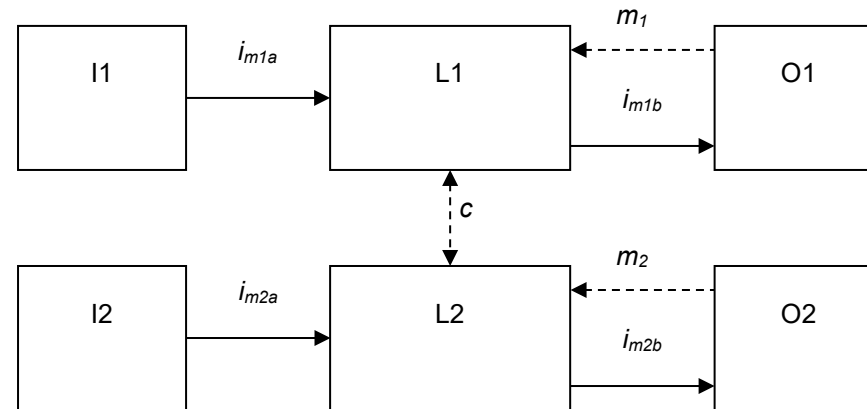

Solid lines represent the STO control paths.

Dashed lines represent reasonably practicable fault detection.

Key:

I1, I2 = user terminal

L1, L2 = logic

O1, O2 = methods of enabling or disabling output power devices

i_{mxy} = interconnecting means

m_x = monitoring

c = cross monitoring

8-4 Safe Torque Off

- **Category 3 general requirements are:**
 - A single failure, and any consequential failures, will not lead to loss of the STO safety function.
 - Failure of more than one component can lead to the loss of the STO safety function.
 - Most but not all single component failures will be detected. Diagnostic Coverage (DC) is required to be at least 60% (i.e. the minimum required for 'low' diagnostic coverage).
 - Detected component failures will result in the STO function being applied without intervention from the user.
 - The risk associated with the loss of STO safety function caused by multiple failures must be understood and accepted by the user.
 - The user must undertake a risk analysis and specify suitable components that, when connected together, meet the risk assessment requirements.
 - Mean Time To Failure (dangerous) (MTTFd) of each STO channel must be ≥ 30 years.
 - Common Cause Failure (CCF) score must be ≥ 65 according to Annex F of the standard.
- **Performance Level (PL) e:**
 - Average probability of dangerous failure per hour (PFH) must be $\leq 10^{-7}$

EN61800-5-2:2007 and EN61508

(Adjustable speed electrical power drive systems) and (Functional safety of electrical/electronic/programmable electronic safety-related systems)

STO aligns to the following aspects of this standard:

- **Safety Integrity Level (SIL) 3**
 - Probability of dangerous random hardware failures per hour (PFH) must be $\leq 10^{-7}$
 - Subsystems type A according to EN61508-2:2001 para 7.4.3.1.2
 - Hardware Fault Tolerance (HFT) = 1
 - Safe Failure Fraction (SFF) must be $\geq 90\%$

Safety Specification

As assessed to EN ISO13849-1 and EN61800-5-2 the inverter has the following related safety values:-

Criterion	Requirement	Value achieved
SIL3	For type A subsystems, HFT = 1: SFF ≥ 60%	SFF = 99%
SIL3	$10^{-7} \geq \text{PFH} \geq 10^{-8}$	PFH = 2.3×10^{-9}
SIL Capability	-	3
PLe	Category 3; $\text{PFH} \leq 4,29 \times 10^{-8}$	PFH = 2.3×10^{-9}
PLe	$30 \text{ years} \leq \text{MTTFd} \leq 100 \text{ years}$	MTTFd = 100 years ¹
PLe	DC = medium	DC = Medium
Mission Time	20 years	20 years
Fault Reaction Function	-	Latched STO ²

Note: all values quoted in this table are valid only when the two STO user inputs are driven independently. This is as required by EN ISO 13849-1 category 3. See the Alignment to European Standards section in this chapter for the required architecture which must be used throughout the machine design relevant to the drive under consideration.

¹ EN ISO13849 limits MTTFd to 100 years.

² A detected fault in the STO circuit causes STO to become active, and remain active until after a power cycle.

8-6 Safe Torque Off

EMC Specification

In addition to the mandatory requirements of EN61800, the STO functionality has been subjected to testing for immunity at higher levels. In particular the STO function (only) has been tested for radiated immunity according to EN62061:2005 Annex E up to 2.7GHz which includes frequencies used by mobile telephones and walkie-talkies.

User Connections

The STO terminals are on a 6-way terminal block X10. This is mounted on the inverter control housing. Terminal designations are:

Terminal Number	Terminal Name	Description
X10/01	STO A Input	0V or not connected = drive will not run, STO is active on channel A. 24V = drive is enabled to run if X10/03 is also 24V. This input is optically isolated from all other inverter terminals except X10/02, X10/03 and X10/04.
X10/02	STO Common ³	Signal return for STO A Input and STO B Input. Connected internally to X10/04. This terminal or X10/04 must be connected to earth at one common point in the drive system.
X10/03	STO B Input	0V or not connected = drive will not run, STO is active on channel B. 24V = drive is enabled to run if X10/01 is also 24V. This input is optically isolated from all other inverter terminals except X10/01, X10/02 and X10/04.
X10/04	STO Common ²	Signal return for STO A Input and STO B Input. Connected internally to X10/02. This terminal or X10/02 must be connected to earth at one common point in the drive system.
X10/05	STO Status A	Together with X10/06, this terminal forms an isolated solid-state relay output. This output is ON (equivalent to closed relay contacts) when the STO circuit is in the 'safe' state, i.e. the drive will not cause its motor to produce torque. However, this output should be used primarily as an indication. In the unlikely event of a fault in the STO circuit, this output could turn on erroneously to give a false indication of the STO status. It must not be used as a guarantee that the motor will not produce torque. The solid-state relay is protected by a self-resetting fuse.
X10/06	STO Status B	Together with X10/05, this terminal forms an isolated solid-state relay output. See the description for X10/05.

³ Do not connect both X10/02 and X10/04 to earth, otherwise an earth loop could be created.

8-8 Safe Torque Off

Examples of wiring to X10/05 and X10/06.

Active high output:

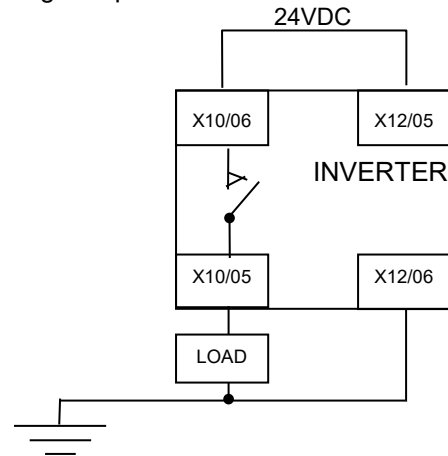

The load is energised and X10/05 is high when STO is in the intended safe STO state.

Active low output:

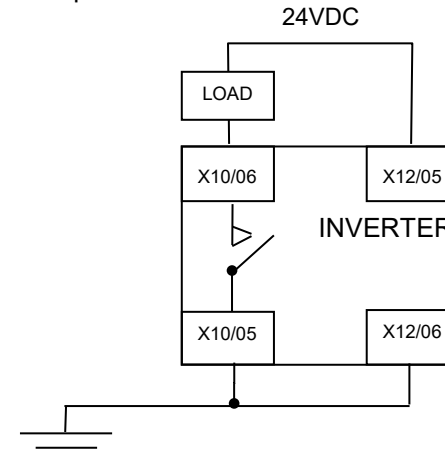

The load is energised and X10/06 is low when STO is in the intended safe STO state.

The examples show the use of the 24V supply provided on X12/05 (+24V) and X12/06 (0V) as source of power to a load. Alternatively an external 24V supply could be used.

Note: If a drive is powered from 24V only, i.e., 24V is applied to terminals X12/05 or X12/06 and the 3 phase power is off, the STO user output will still reflect the status of the two STO user inputs.

STO Technical Specification

Inputs Specification

STO A Input and STO B Input comply with IEC61131-2. Note: inputs do not have hysteresis.

Recommended input voltage for low level:	0V to +5V
Recommended input voltage for high level:	+21.6V to +26.4V
Typical input threshold voltage:	+10.5V
Indeterminate input range:	+5V to +15V. Function is undefined.
Absolute maximum input voltage:	-30V to +30V
Typical input current @ 24V	9mA
Fault detection time ⁴ :	2.3sec typical; < 1.6sec will not generate a fault > 3.0sec will generate a fault.
Response time ⁵	> 2ms 6ms typical < 10ms
Conditions in which the STO inputs are operative:	All, i.e. STO cannot be disabled in any condition

Output Specification

OFF state:	Maximum applied voltage:	±30V (X10/06 relative to X10/05)
	Leakage current:	Less than 0.1mA.
ON state:	Maximum output current:	150mA
	Overcurrent protection:	Included
	Resistance between output terminals:	Less than 6Ω.



WARNING

WIRED CONNECTIONS TO TERMINALS X10/01, X10/03, X10/05 AND X10/06 MUST BE LESS THAN 25 METRES IN LENGTH AND REMAIN WITHIN THE CUBICLE OR DRIVE ENCLOSURE. PARKER IS NOT LIABLE FOR ANY CONSEQUENCES IF EITHER CONDITION IS NOT MET.

⁴ A fault is defined in this context as STO A Input and STO B Input being sensed in opposite logic states.

⁵ Response time is the time from the first STO input becoming active (voltage level is low) until torque production has ceased

8-10 Safe Torque Off

Truth Table

Overview	STO Input A X10/01	STO Input B X10/03	Drive Function	STO Status Output X10/05, X10/06
STO Active	0V	0V	Drive cannot start or supply power to its motor. STO trip reported. This is the intended safe state of the product with correct dual-channel operation.	ON
Abnormal one-channel operation detection	24V	0V	Drive cannot start or supply power to its motor. STO trip reported. If either of these conditions persists for more than 3.0 seconds (the maximum fault detection time), the STO function will lock into a fault state. The drive cannot start until the fault is rectified; all power is removed and reapplied (both mains and any auxiliary 24V dc power).	OFF
	0V	24V	This is single channel operation and thus deemed not as intended for category 3 / PLe / SIL3 structure implementation.	
STO Inactive	24V	24V	Drive is enabled to run under software control. The drive can supply power to its motor.	OFF
Drive unpowered	Don't care	Don't care	Drive cannot start or supply power to its motor.	OFF

STO Input Timing Diagrams

Ideal Operation

In ideal operation, both inputs X10/01 and X10/03 should change state simultaneously reflecting true dual-channel operation as intended.

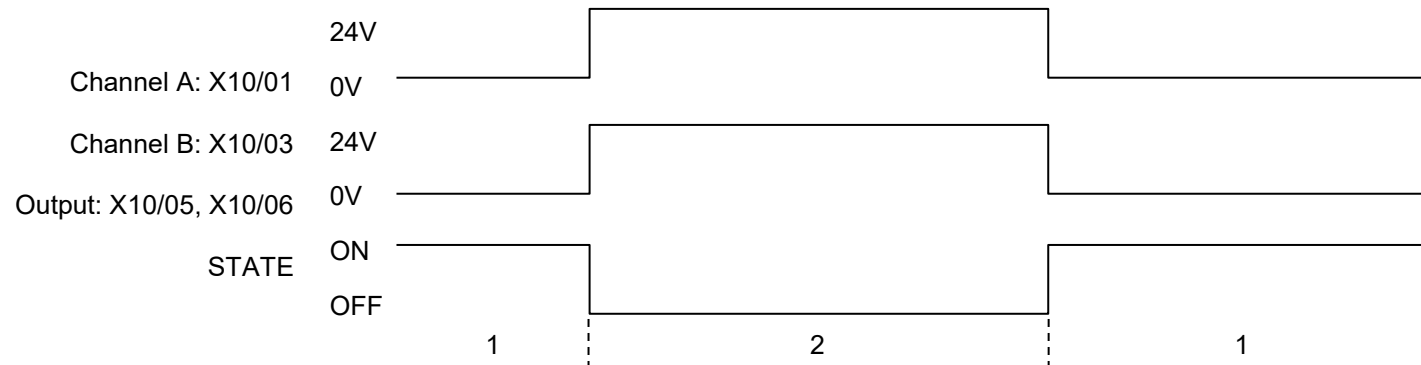

States:

- 1 Both inputs are low. Drive is tripped and STO prevents the drive from starting. User output is ON. This is the “safe torque off” state of the drive.
- 2 Both inputs are high. Drive is able to run under software control. User output is OFF.

8-12 Safe Torque Off

Typical Operation

In typical operation, there can be a small time difference between changes of state on X10/01 and X10/03, due to different delays in the operation of two sets of relay contacts.

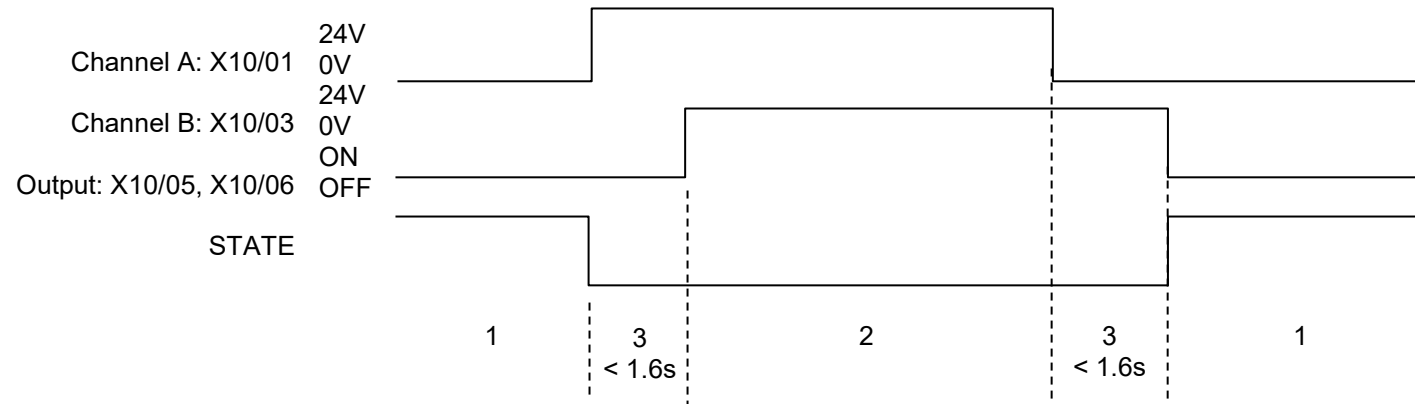

States:

- 1 Both inputs are low. Drive is tripped and STO prevents the drive from starting. User output is ON. This is the “safe torque off” state of the drive.
- 2 Both inputs are high. Drive is able to run under software control. User output is OFF.
- 3 One input is high and the other input is low. Drive is tripped and cannot start due to STO action. User output is OFF. Normal operation allows this state to persist for up to 1.6 seconds which is the minimum fault detection time required to generate a fault (3.0 seconds is the maximum). These tolerable time differences are normally caused by switches or relays; they should be kept as short as possible.

Fault Operation

A fault is always detected when X10/01 and X10/03 are in opposite states for more than 3.0 seconds.

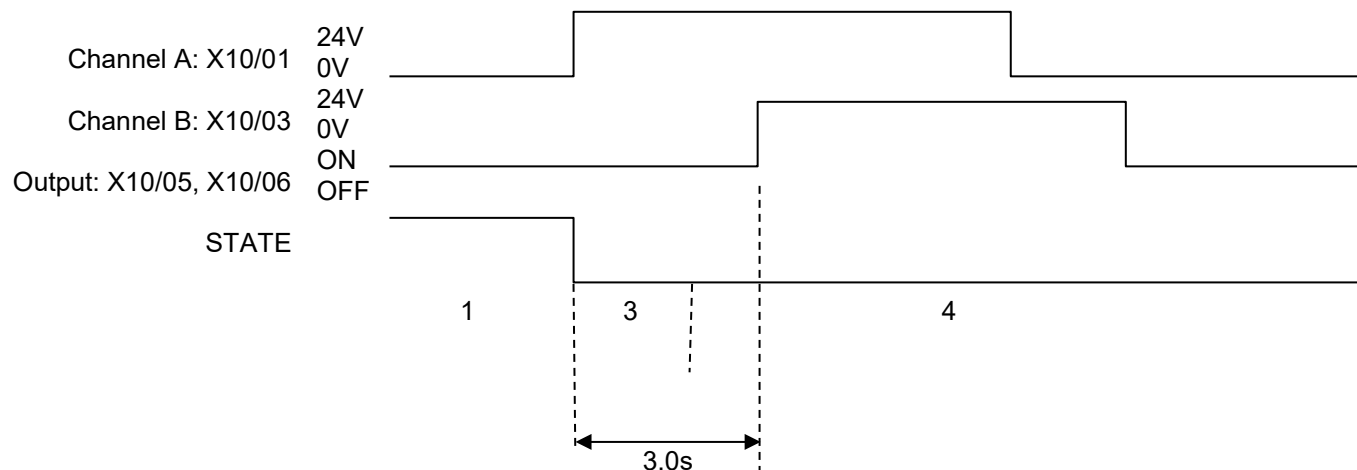

States:

- 1 Both inputs are low. Drive is tripped and STO prevents the drive from starting. User output is ON. This is the “safe torque off” state of the drive.
- 3 One input is high and the other input is low. Drive is tripped and STO prevents the drive from starting. In this example, this state persists for more than 3.0 seconds (being the maximum fault detection time), after which time the STO logic transitions to state 4 without further changes in input state. The inverter has detected a fault or single-channel operation.
- 4 The fault state (one input high, the other input low) has persisted for longer than 3.0 seconds (being the maximum fault detection time). The STO hardware logic locks into state 4. The drive is tripped and the STO function prevents the drive from starting. User output is OFF. To exit from state 4, the drive must be powered off (all power removed including any auxiliary 24Vdc) and back on.



DANGER

OPERATION OF THE INVERTER UNIT SHOULD CEASE IMMEDIATELY AND THE UNIT SHOULD BE RETURNED TO A PARKER AUTHORIZED REPAIR CENTRE FOR INVESTIGATION AND REPAIR.
FAILURE TO DO SO COULD RESULT IN INJURY, DEATH OR DAMAGE.
FURTHER OPERATION OF THE INVERTER WITHOUT RESOLVING THIS FAILURE IS ENTIRELY AT THE USER'S OWN RISK.
SEE SAFETY CATEGORY DEFINITIONS AND LIMITATIONS, REFER TO EN ISO 13849-1:2008.

8-14 Safe Torque Off

Pulsed Inputs

Some safety equipment, e.g. safety PLCs, regularly pulse the two STO inputs independently in order to detect a short circuit between them. This is commonly known as OSSD (Output Signal Switch Device). The inverter STO inputs are immune to such pulses when they are less than 2ms in width. The product will not react to such pulses and therefore will not inadvertently invoke the STO function.

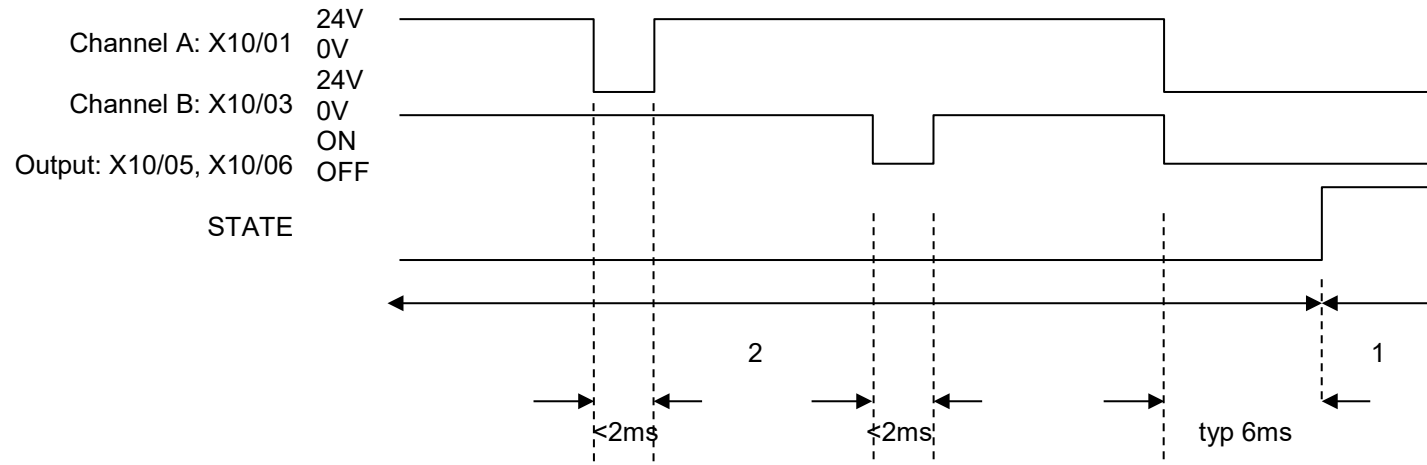

States:

- 1 Both inputs are low. Drive is tripped and STO prevents the drive from starting. User output is ON. This is the "safe torque off" state of the drive.
- 2 Both inputs are high, but regularly pulse low independently. External equipment can thus detect a short circuit between the two STO user inputs. Each input must remain low for 6ms (typical) before the inverter reacts to it.

STO State Transition Diagram

The flow chart below shows how the drive responds to STO inputs, start and stop commands.

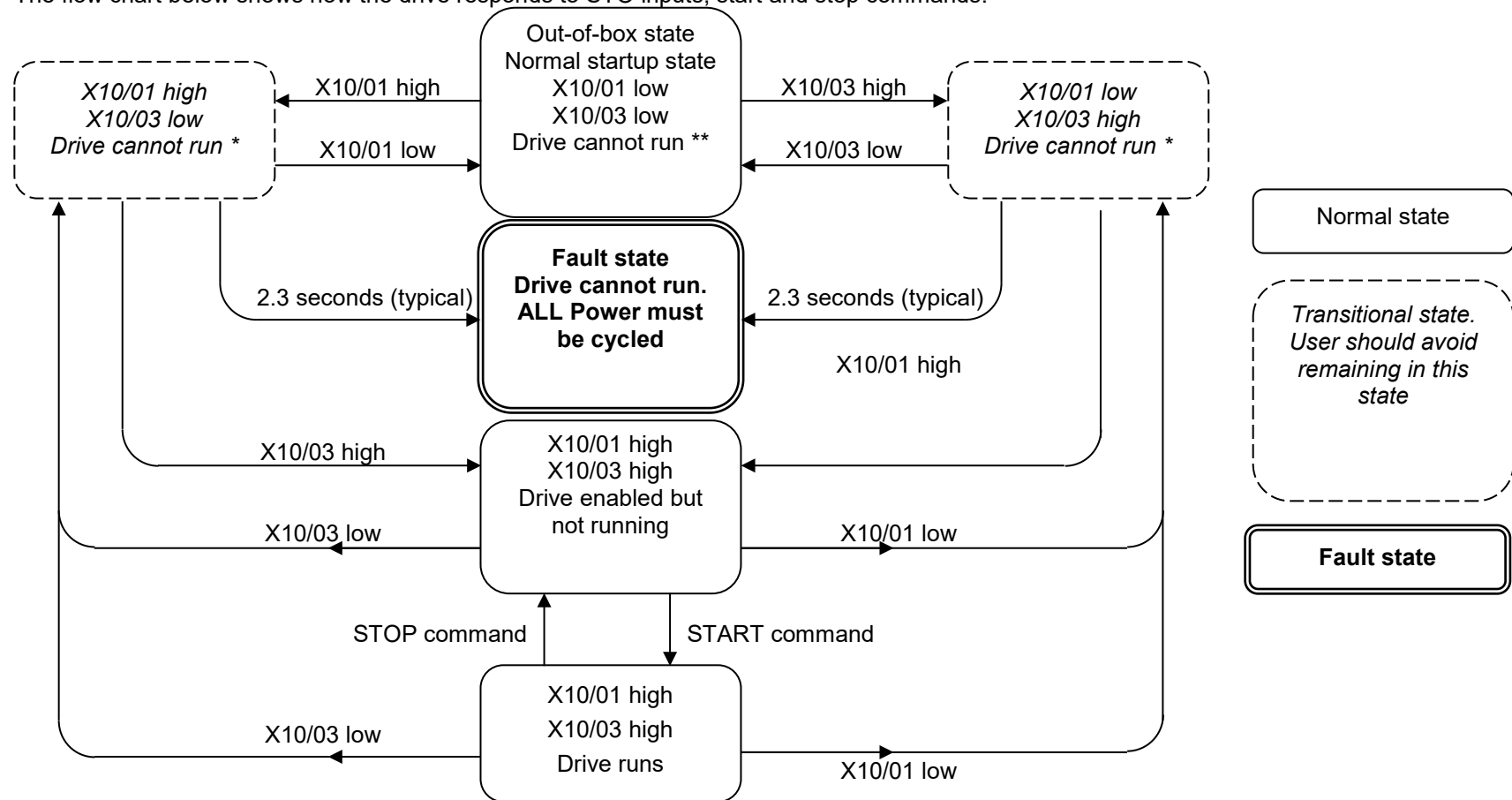

Key:
 * = One channel operation
 ** = Two channel operation

8-16 Safe Torque Off

STO Trip Annunciation

The GKP will display a STO trip message when STO becomes active, i.e. STO prevents the drive from starting, thus:



GKP Display

This message is displayed immediately if, on starting the drive or whilst the drive is running:

- One or both STO user inputs X10/01 or X10/03 is low when the user attempts to start the drive, or
- One or both STO user inputs X10/01 or X10/03 goes low while the drive is running, or
- The inverter has detected a fault in the STO circuit.

Note: an out-of-box inverter will report this trip if the drive, as supplied, has no connections to X10 when it is first started. Appropriate connections must be made to X10 to prevent this trip from occurring, as described elsewhere in this chapter. The user must decide if STO is to be permanently inactive, or to make use of the STO feature. If the STO feature is not required, see the “Applications that do not require STO function” section on page 8-19.

STO is inserted into the trips history buffer (see Chapter 10 Trips & Fault Finding) if STO is active when the drive is commanded to start or if STO becomes active while the drive is running, indicating an abnormal condition. The trips history buffer is not updated if STO becomes active while the drive is not running.

Note: The normal method of operation is for STO to become active while the drive is not running and the motor is stationary.

Appropriate, application specific risk assessment is necessary when STO is activated on rotating motors, moving loads or when external forces such as gravitation or inertial loads act on the motor.



Safety Warnings and Limitations



- Only competent personnel are permitted to install the STO function and commission it. They must disseminate and make available all appropriate instructions and documentation to all personnel who may come into contact with or operate the STO and provide suitable training on the inverter to ensure it is operated in the correct manner and to avoid damage, injury or loss of life.
- The inverter STO function is a factory-fitted and factory-tested feature. Repairs to the inverter STO featured-product are to be carried out only by Parker authorized repair centres. Any unauthorised attempt to repair or disassemble the product will render any warranty null and void, and STO integrity could be impaired. **PARKER WILL NOT ACCEPT ANY LIABILITY FOR FAILURE TO OBEY THESE INSTRUCTIONS OR FOR ANY CONSEQUENTIAL INJURY, DEATH, LOSS OR DAMAGE.**
- It is important that the inverter product environment including all aspects of its CE conformance and IP etc., specified elsewhere in this manual, is maintained to ensure the safety integrity of the STO function.
- Should synchronous motors be operated in the field weakening range, operation of the STO function may lead to overspeed and destructive overvoltages as well as explosions in the drive. Therefore, the STO function must NEVER be used with synchronous drives in the field-weakening range. The user must ensure this condition is prevented.
- When using synchronous permanent magnet motors, shaft movement over a small angle is possible if two faults occur simultaneously in the power section of the drive. This depends on the number of motor poles. The maximum angle is:
 - Rotary motors: $360^\circ / \text{number of poles}$.
 - Linear motors: 180° electrically.
 It is the user's responsibility to assess, validate and safeguard as necessary against this potential hazard.
- If external forces can act on the motor and/or load to cause it to move, additional measures must be taken by the user to restrain it, for example a mechanical brake. Examples of external forces are suspended loads (effect of gravity), and other web-tensioning devices.
- The inverter STO feature does not provide or guarantee any galvanic isolation in accordance with EN 60204-1:2006 A1:2009 Section 5.5. This means that the entire system must be isolated from the mains power supply with a suitable electrical isolation device before any drive or motor maintenance or replacement procedures are attempted. Note that even after the power has been isolated, dangerous electrical voltages may still be present in the inverter. Safe discharge times and details are specified in Chapter 1 Safety of this manual.
- The STO function must not be used for electrical isolation of the inverter and power. Whenever any personnel require to work on the drive, associated motor or other power items, they must always use recognised and suitable electrical isolation devices.
- Terminal X10/02 or X10/04 must be connected to earth at one common point in the drive system. For multi-drive systems this can be a shared earth point.
- The STO user output, serial communications or GKP messages relating to accessing or viewing any safety monitoring statuses are for information only and should not be relied on. They are not part of the drive module safety system and its associated PL/SIL declared ratings. Any customer use of these must be appropriately risk assessed in accordance with the relevant standards or regulations.
- The STO safety function must be tested regularly. The frequency should be determined by the machinery builder. An initial minimum frequency of once per week is suggested. Refer to page 8-25 and following pages.
- When using an external safety control unit with adjustable time delay, for example when implementing an SS1 function, the time delay must be protected to prevent unauthorized adjustment. The adjustable time delay on the safety control unit must be set to a value greater than the duration of the braking ramp controlled by the inverter with maximum load inertia and from maximum speed. Any external forces must also be considered, e.g. effects due to gravity.

8-18 Safe Torque Off

- When implementing a SS1 function with the inverter, the user is responsible for ensuring the drive's configuration will allow a controlled braking ramp to be initiated by the external safety device. This is particularly important when using serial link communications for normal control of the drive.
- During the active braking phase of SS1 or Stop category 1 (controlled stop with safely monitored time delay according to EN60204-1:2006), faulty operation of the drive must be allowed for. If a fault in the drive system occurs during the active braking phase, the load may coast to a stop or might even actively accelerate until expiration of the defined time delay. It is not the remit of this document to specify these measures. This is for the user to assess.
- When the inverter detects either an internal STO fault or an external single-channel user fault, the user must immediately fully resolve the fault. The user must ensure dual-channel operation has been fully restored before attempting to use the inverter STO safety feature.



DANGER

FAILURE TO DO SO COULD RESULT IN STO NOT BEING ACHIEVABLE, AND THUS THE MOTOR MAY ROTATE UNEXPECTEDLY AND COULD RESULT IN INJURY, DEATH OR DAMAGE. FURTHER OPERATION OF THE INVERTER WITHOUT RESOLVING THIS FAILURE IS ENTIRELY AT THE USER'S OWN RISK. SEE SAFETY CATEGORY DEFINITIONS AND LIMITATIONS, REFER TO EN ISO 13849-1:2008.

- It is the user's responsibility to ensure that their overall control implementation recovers safely from supply loss or dips.
- In all instances it is the user's responsibility formally to perform suitable risk assessments, and invoke and fully validate the necessary risk reduction measures after having thoroughly understood the application, the drive product and its features. Of special relevance is to assess the risk of the two STO user inputs shorting together.

Example User Wiring

**WARNING**

THE WIRING EXAMPLES SHOWN IN THIS SECTION ARE FOR ILLUSTRATION ONLY. THEY ARE NOT TO BE CONSIDERED FINAL DESIGNS, NOR AS AN ATTEMPT TO CREATE A DESIGN FOR SPECIFIC SOLUTIONS. THE USER / INSTALLER IS RESPONSIBLE FOR DESIGNING A SUITABLE SYSTEM TO MEET ALL REQUIREMENTS OF THE APPLICATION INCLUDING ASSESSING AND VALIDATING IT. PARKER WILL NOT ACCEPT ANY LIABILITY FOR FAILURE TO DO THIS OR FOR ANY CONSEQUENTIAL LOSS OR DAMAGE.

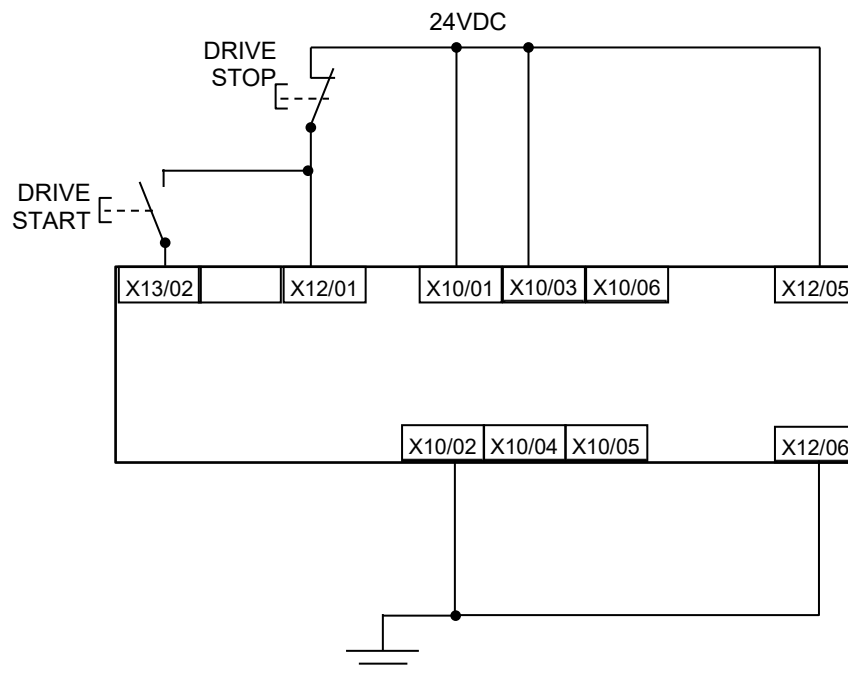
Applications that do not require STO function

STO inputs X10/01 and X10/03 must be connected to 24VDC with respect to terminals X10/02 or X10/04. STO Status output on X10/05 and X10/06 may be left disconnected. All wiring shown is within the control cubicle.

Here the STO inputs X10/01 and X10/03 have been set to the inactive state (tied to +24V). Drive control is performed solely through software with no inherent safety function. The drive is controlled with its own start and stop pushbuttons.

Note: Only X10/02 or X10/04 must be earthed, i.e. they should not both be earthed otherwise it is possible to create an earth loop.

8-20 Safe Torque Off

Minimum STO Implementation

This example shows the minimum connections required. To reset from STO requires that STO Request contacts are closed to permit normal drive operation. The user must do a risk assessment to ensure that all safety requirements are met. The user must select and assess appropriate equipment.

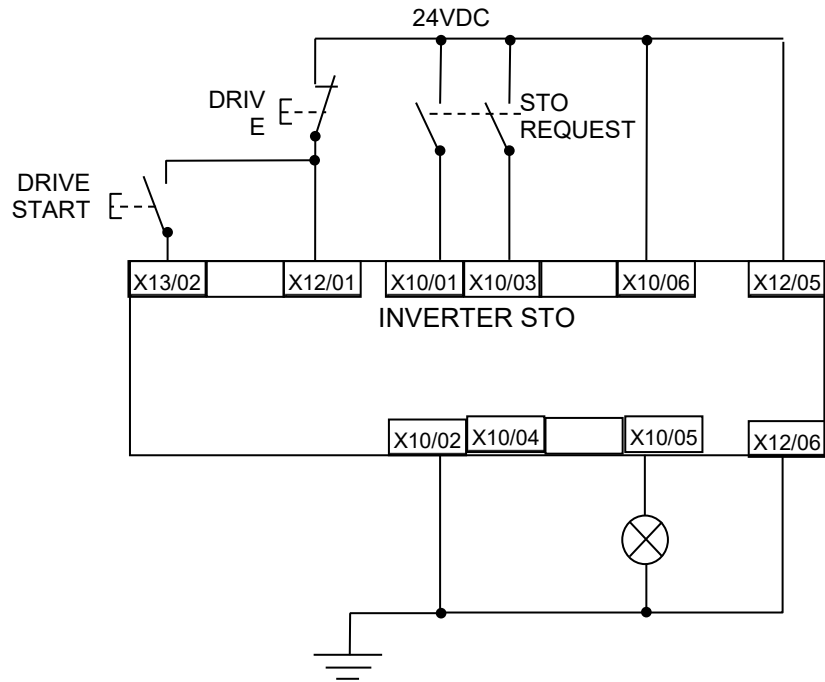

To run the drive:

Ensure the STO Request contacts are closed.
Press the DRIVE START button.

To perform operational (not STO) stop:

Press the DRIVE STOP button.
Wait for the motor to come to rest.

To invoke STO:

Press the DRIVE STOP button.

Wait for the motor to come to rest.

Open the STO Request contacts simultaneously. The contacts must remain open for the entire duration that STO is required: they must not be momentary action switches.

The drive will confirm via X10/05 that STO has been invoked by the lamp being ON.

If the lamp is OFF, do not access the machine as a fault may be present.

Note: if the STO Request contacts open while the motor is rotating, the motor will coast to rest (unless external forces act on it).

Note: all wiring shown is within the control cubicle.

STO Implementation with Safety Control Unit

This example improves on the previous one by showing the resetting from a STO stop. The example shows wiring and terminal numbering for a Siemens 3TK2827, but similar products are available from other vendors. Use of this Siemens part does not imply it is suitable for the user's application. The user must select and assess appropriate equipment.

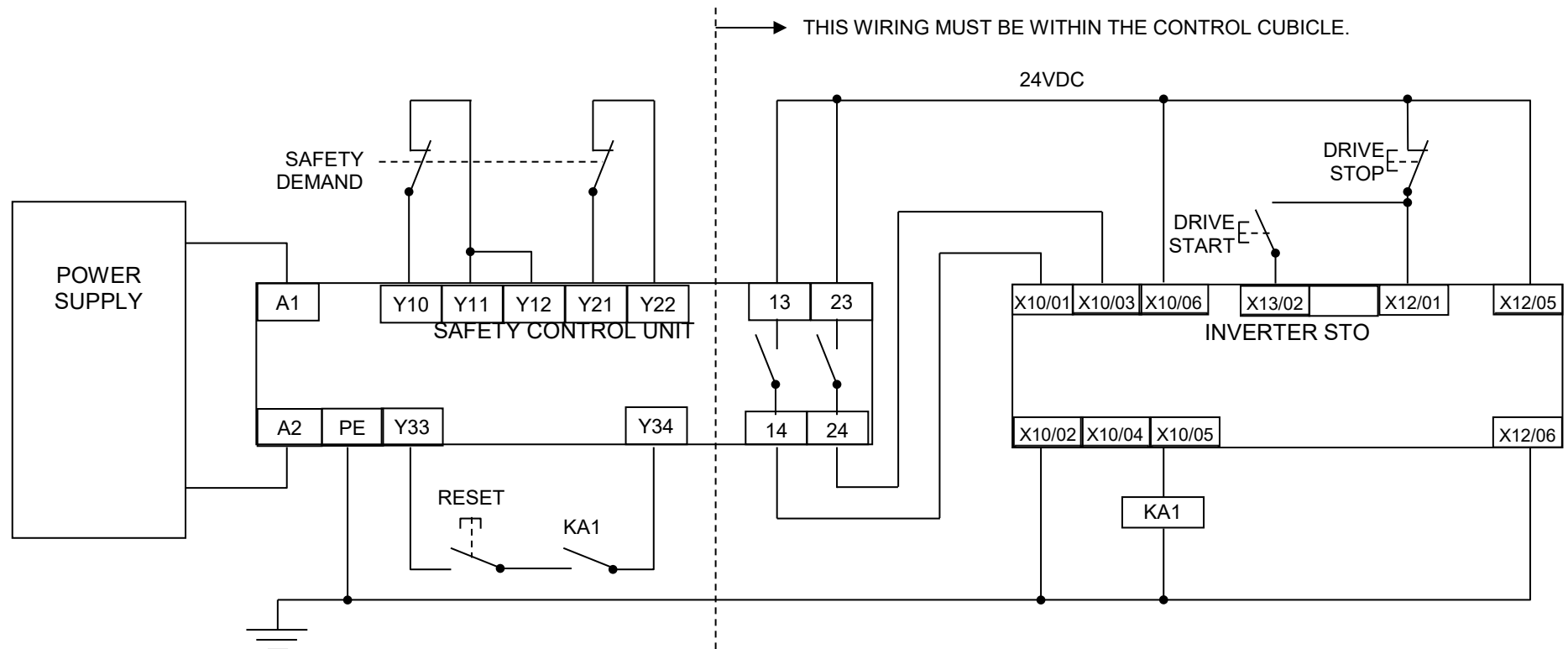

Note: On power-up, the safety control unit outputs are OPEN; thus the STO state is requested of the inverter. The latter responds by energising KA1 if both channels are active and healthy. KA1 is used as a self-check for the reset cycle of the safety control unit. If a reset cannot be achieved due to KA1 being de-energised, a fault may be present and must be resolved by the user before relying on the STO function. See Fault Operation on page 8-13.

8-22 Safe Torque Off

To start the drive:

Ensure the Safety Demand switch is reset (contacts closed). Press the RESET button to ensure the Safety Control Unit is reset; its contacts to the inverter should close making the STO function inactive. The inverter STO output should then turn OFF. Then press the DRIVE START button.

To perform operational stop (non STO):

Press the DRIVE STOP button.
Wait for the motor to come to rest.

To invoke STO:

Press the DRIVE STOP button.
Wait for the motor to come to rest.

Operate the Safety Demand switch (contacts open) that causes the safety control unit to open its output contacts together. In response, the drive will confirm, by energising KA1 via X10/05, that STO has been invoked. The user may wish / require that this is verified by mechanisms not shown on this drawing.



DANGER

IF KA1 IS DE-ENERGISED, DO NOT ACCESS THE MACHINE AS A FAULT MAY BE PRESENT. THE USER MUST RESOLVE THE DETECTED FAULT BEFORE USING THE STO FEATURE. FAILURE TO DO SO COULD RESULT IN STO NOT BEING ACHIEVABLE, AND THUS THE MOTOR MAY ROTATE UNEXPECTEDLY AND COULD RESULT IN INJURY, DEATH OR DAMAGE. PARKER WILL NOT ACCEPT ANY LIABILITY FOR FAILURE TO DO THIS OR FOR ANY CONSEQUENTIAL LOSS OR DAMAGE.

Note: if either channel of the Safety Demand is requested while the motor is rotating, the motor will coast to rest unless external forces act on it.

SS1 Implementation using Safety Control Unit

This Safe Stop 1 (SS1) implementation causes the drive to come to rest in a controlled manner, and STO is actioned after a time delay determined by the safety delay relay. This conforms to SS1 defined in EN61800-5-2:2007 para 4.2.2.3 c). The example shows wiring and terminal numbering for a Siemens 3TK2827, but similar products are available from other vendors. Use of this Siemens part does not imply it is suitable for the user's application. The user must select and assess appropriate equipment.

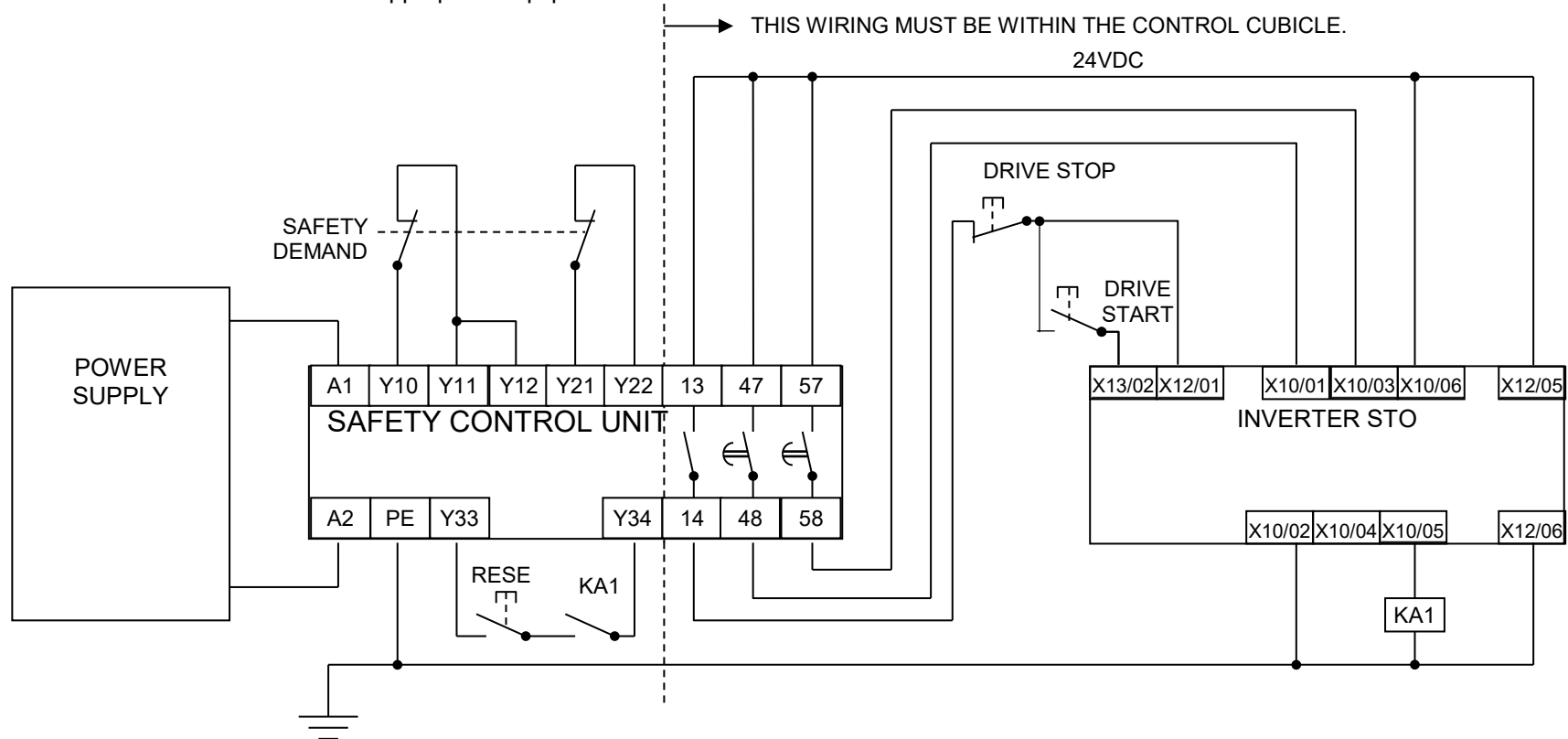

Note: On power-up, the Safety Control Unit outputs are OPEN; thus STO is requested of the inverter. This responds by energising KA1 if both channels are active and healthy. KA1 is used as a self-check for the reset cycle of the Safety Control Unit. If a reset cannot be achieved due to KA1 being de-energised, a fault may be present and must be resolved by the user before relying on the STO function. See Fault Operation on page 8-13.

To start the drive:

Ensure the Safety Demand switch is reset (contacts closed). Press the RESET button to ensure the Safety Control Unit is reset; its contacts to the inverter should close making the STO function inactive. The inverter STO output should then turn OFF. Then press the DRIVE START button.

To perform operational stop (non STO):

Press the DRIVE STOP button.
Wait for the motor to come to rest.

8-24 Safe Torque Off

To invoke SS1:

Operate the Safety Demand switch (contacts open). This should cause the Safety Control Unit to open its instantaneous output, shown here as a single channel. This causes the drive to decelerate to rest using its own software which is not safety critical in this instance.

Note: the drive's block diagram must be configured to provide this ramp to rest functionality.

After a time delay set in the Safety Control Unit, the pair of delayed OFF output contacts open together. This time delay must be set longer than the worst case time for the motor to come to rest.

In response, the drive will confirm, by energising KA1 via X10/05, that STO has been invoked. The user may wish / require that this is verified by mechanisms not shown on this drawing.



DANGER

IF KA1 IS DE-ENERGISED, DO NOT ACCESS THE MACHINE AS A FAULT MAY BE PRESENT.

THE USER MUST RESOLVE THE DETECTED FAULT BEFORE RELYING FURTHER ON THE STO FEATURE.
FAILURE TO DO SO COULD RESULT IN STO NOT BEING ACHIEVABLE, AND THUS THE MOTOR MAY ROTATE UNEXPECTEDLY AND COULD RESULT IN INJURY, DEATH OR DAMAGE. PARKER WILL NOT ACCEPT ANY LIABILITY FOR FAILURE TO DO THIS OR FOR ANY CONSEQUENTIAL LOSS OR DAMAGE.

Note: if either of the delayed OFF output contacts in the Safety Control Unit open while the motor is rotating, the motor will coast to rest (unless external forces act on it).

STO Function Checking

Two levels of checking are required: a comprehensive check and a regular check.

The user / machine builder must determine the frequency of these checks based on their knowledge, use of the machine, appropriate standards and any legal requirements.



DANGER

ALL TESTS MUST PASS. IF ANY TEST FAILS, IT MUST BE INVESTIGATED AND RECTIFIED BEFORE ATTEMPTING TO PUT THE EQUIPMENT INTO SERVICE.
FURTHER OPERATION OF THE INVERTER WITHOUT RESOLVING THIS FAILURE IS ENTIRELY AT THE USER'S OWN RISK. FAILURE TO DO SO COULD RESULT IN INJURY, DEATH OR DAMAGE. PARKER WILL NOT ACCEPT ANY LIABILITY FOR FAILURE TO DO THIS OR FOR ANY CONSEQUENTIAL LOSS OR DAMAGE.
SEE SAFETY CATEGORY DEFINITIONS AND LIMITATIONS, REFER TO EN ISO 13849-1:2008.

When STO becomes active during any test, power to the motor must be seen by the user to be quenched instantaneously. Note: the drive should respond in less than 10 milliseconds.

All STO checks should be performed after the inverter has been commissioned for speed control.

8-26 Safe Torque Off

Comprehensive Check

A comprehensive check of the STO function ensures the overall integrity of the STO functionality. It proves the independent operation of each channel individually (including during the normal dual channel operation), the STO user feedback operation, and the essential single fault detection.

It must always be performed:

- During factory test
- During commissioning activities
- After repair or replacement of the inverter
- After any hardware or software design changes which may affect the inverter concerned.
- After each intervention into the system and control wiring.
- At defined maintenance intervals as determined by the machine builder and /or user risk assessments and associated verification assessments.
- If the machine has been idle for more than a period of time determined by the machinery builder and user risk assessments.

The check must be made by suitably qualified professional personnel following all necessary safety precautions. They must be fully conversant with all equipment concerned.

NOTE: In the following text where it is required that “all power” is removed. Remove power and wait 5 minutes.

The performance of the individual test steps of the STO function should be logged.



WARNING

DURING THIS TEST, THE SAFETY FUNCTION MUST NOT BE RELIED ON BECAUSE AT TIMES ONLY ONE CHANNEL WILL BE ACTIVATED AND THEREFORE THE INTENDED SAFETY FUNCTION MAY NOT BE AVAILABLE. ALSO STO WILL BE ACTIVATED WHILE THE MOTOR IS ROTATING, WHICH IS NOT THE NORMAL OPERATION. THEREFORE THE USER MUST ENSURE IT IS SAFE TO DO THIS TEST BY USING AN APPROPRIATE RISK ASSESSMENT AND TAKING ANY ADDITIONAL RISK REDUCTION MEASURES.

The following test steps must be performed:

Initial Check:

STO test	Comprehensive Check, Activity	Expected reaction and effect
1	Ensure that no harm can come to personnel or equipment if the motor turns.	
2	Apply +24V DC to terminals X10/01 and X10/03.	
3	Switch on power to the drive.	No error must be present in the drive system. X10/05 and /06 must be OFF.
4	Configure the drive and associated equipment if necessary so that it can be started and stopped, and a speed setpoint provided.	No error must be present in the drive system. X10/05 and /06 must be OFF.
5	Try to start the drive with a non-zero setpoint. This setpoint value will be referred to as SPT1 for brevity in these tests. Leave this set throughout all tests.	Drive must start and motor must turn at SPT1. X10/05 and /06 must be OFF.

Channel A Check:

STO test	Comprehensive Check, Activity	Expected reaction and effect
6	With drive running and motor turning at SPT1, momentarily disconnect terminal X10/01 (maximum duration of disconnect = 1 second), while retaining +24V at terminal X10/03.	Motor must immediately coast to rest. Drive must report STO trip immediately. X10/05 and /06 must remain OFF.
7	Ensure terminals X10/01 and X10/03 are both 24V. Try to restart the drive.	Drive must restart at SPT1. STO trip must clear. X10/05 and /06 must remain OFF.

Channel B Check:

STO test	Comprehensive Check, Activity	Expected reaction and effect
8	With drive running and motor turning at SPT1, momentarily disconnect terminal X10/03 (maximum duration of disconnect = 1 second), while retaining +24V at terminal X10/01.	Motor must immediately coast to rest. Drive must report STO trip immediately. X10/05 and /06 must remain OFF.
9	Ensure terminals X10/01 and X10/03 are both 24V. Try to restart the drive.	Drive must restart at SPT1. STO trip must clear. X10/05 and /06 must remain OFF.

Channel A Fault Check:

STO test	Comprehensive Check, Activity	Expected reaction and effect
10	Ensure the drive is running and the motor is turning at SPT1. Disconnect terminal X10/01 for approximately 5 seconds (must exceed 3 seconds).	Motor must immediately coast to rest. Drive must report STO trip immediately. X10/05 and /06 must remain OFF.
11	The STO function has latched in hardware to disable the drive. Re-apply 24V to terminal X10/01, and then try to restart drive.	Drive must not start. Drive must continue to report STO trip. X10/05 and /06 must remain OFF.
12	Remove and re-apply all power to the drive	X10/05 and /06 must be OFF.
13	Try to restart drive at SPT1.	Drive must start at SPT1. X10/05 and /06 must remain OFF.

8-28 Safe Torque Off

Channel B Fault Check:

STO test	Comprehensive Check, Activity	Expected reaction and effect
14	Ensure the drive is running and the motor is turning at SPT1. Disconnect terminal X10/03 for approximately 5 seconds (must exceed 3 seconds).	Motor must immediately coast to rest. Drive must report STO trip immediately. X10/05 and /06 must remain OFF.
15	The STO function has latched in hardware to disable the drive. Re-apply 24V to terminal X10/03, and then try to restart drive.	Drive must not start. Drive must continue to report STO trip. X10/05 and /06 must remain OFF.
16	Remove and re-apply all power to the drive	X10/05 and /06 must be OFF.
17	Try to restart drive at SPT1.	Drive must start at SPT1. X10/05 and /06 must remain OFF.
18	Stop the drive.	Drive must decelerate to rest. X10/05 and /06 must remain OFF.

User Output Check:

STO test	Comprehensive Check, Activity	Expected reaction and effect
19	Remove connections to X10/01 and X10/03 within 1 second of each other.	X10/05 and /06 must be ON.
20	Try to restart the drive. Wait for at least 10 seconds with the run command active, then remove it.	Drive must not start while run command is given. Drive must report STO trip immediately. X10/05 and /06 must remain ON.
21	Reconnect X10/01 and X10/03 to 24V.	X10/05 and /06 must turn OFF immediately.
22	Try to restart the drive at SPT1.	STO trip must clear. The drive must restart at SPT1.
23	Stop the drive. Test is complete.	Drive must stop.

The tests specified above are the minimum set; further test steps may be required depending on the application, for example a controlled stop should be verified in a SS1 application.

Regular Check

A comprehensive check must take precedence if it coincides with a regular check.

A regular check is intended only to demonstrate the STO is functional. It will not always detect the loss of a single channel. It is therefore important for the user and / or machinery builder to determine the frequency of the comprehensive checks based on their knowledge and application of the machine.

The following tests should be performed:-

STO test	Regular Check, Activity	Expected reaction and effect
1	Ensure that no harm can come to personnel or equipment if the motor turns.	
2	Apply +24V DC to terminals X10/01 and X10/03.	No error must be present in the drive system
3	Apply power to the drive.	X10/05 and /06 must be OFF. No error must be present in the drive system.
4	Try to start the drive with a non-zero setpoint. This setpoint value will be referred to as SPT1 for brevity in these tests. Leave this set throughout all tests.	The drive should start and the motor should turn at SPT1. X10/05 and /06 must remain OFF.
5	Disconnect X10/01 and X10/03 within 1 second of each other and leave disconnected for approximately 5 seconds (must exceed 3 seconds)..	Drive must stop immediately, and report STO trip. X10/05 and /06 must be ON.
6	Re-apply 24V to X10/01 and X10/03.	STO trip indication must remain. X10/05 and /06 must turn OFF.
7	Try to restart drive.	STO trip indication should clear. Drive must restart at SPT1.
8	Stop the drive. Test is complete.	Drive must stop.

8-30 Safe Torque Off

Troubleshooting

Symptom	Examine:			Probable cause	Remedy
	GKP display	User output ⁶	User inputs ⁷		
Drive won't start when given a start command	*** TRIPPED *** SAFE TORQUE OFF	On	Both < 15V	STO is invoked.	When safe to do so, connect X10/01 and X10/03 to 24V ± 10%
	*** TRIPPED *** SAFE TORQUE OFF	Off	Both > 15V and < 30V	Fault latch might have tripped	Remove all power from drive and re-apply. If symptom persists, immediately return the inverter for repair. See the DANGER box below.
	Any other trip message, e.g. overvoltage	Off	Both >15V and < 30V	Drive is tripped, but not due to STO.	Reset the trip, and remove its cause. If symptom persists, return the inverter for repair.
	Any other message	Off	Both >15V and < 30V	Faulty hardware	Return for repair
Drives starts unexpectedly	Don't care	Don't care	Both < 5V	Faulty hardware	Immediately return the inverter for repair. See the DANGER box below.
	Don't care	Off	Both > 5V	STO not invoked by the user.	Use STO according to instructions elsewhere in this chapter.
Drive fails comprehensive or regular STO test	Don't care	Don't care	Don't care	Faulty hardware	Immediately return the inverter for repair. See the DANGER box below.

The table above is only a guide. It may not be a comprehensive list of all possible symptoms relating to STO. Parker will not accept responsibility for any consequences arising from its incompleteness or inaccuracy.

Important note:

- There are no user-serviceable parts in the inverter drive. Refer to the Safety Warnings and Limitations section on page 8-17 of this chapter.



DANGER

IF ANY FAULTY OPERATION OF THE STO FUNCTION IS OBSERVED OR SUSPECTED, OPERATION OF THE INVERTER SHOULD CEASE IMMEDIATELY AND THE UNIT SHOULD BE RETURNED TO PARKER FOR INVESTIGATION AND REPAIR. FAILURE TO DO SO COULD RESULT IN INJURY, DEATH OR DAMAGE.

FURTHER OPERATION OF THE INVERTER WITHOUT RESOLVING THIS FAILURE IS ENTIRELY AT THE USER'S OWN RISK.

SEE SAFETY CATEGORY DEFINITIONS AND LIMITATIONS. REFER TO EN ISO 13849-1:2008

⁶ Continuity through X10/05 and X10/06

⁷ Measure X10/01 and X10/03 relative to X10/02 or X10/04

Chapter 9: The Graphical Keypad

Overview

In most applications, the inverter is fitted with a Graphical Keypad (GKP).

It provides for local control, monitoring, and complete parameter access for advanced operation of the inverter.

Refer to 'Chapter 5: Installation – Control Module' for either direct mounting on the front of the control module, or remote mounting up to 3 metres away.



The GKP has the following features:

- A keypad with 9x pushbuttons on it.
- 2x illuminated pushbuttons that give an indication of the operational status of the inverter.
- Large display that is divided into three areas giving indications of control commands, trip and warning status, communications, modes of operation, menu & parameter lists, and pushbutton actions.
- On board 'Setup Wizard' that can be used to get the user up and running quickly.
- Provides a quick and simple means to perform a 'Firmware Update' (when the control module is fitted with an SD card that has the new firmware pre-loaded).





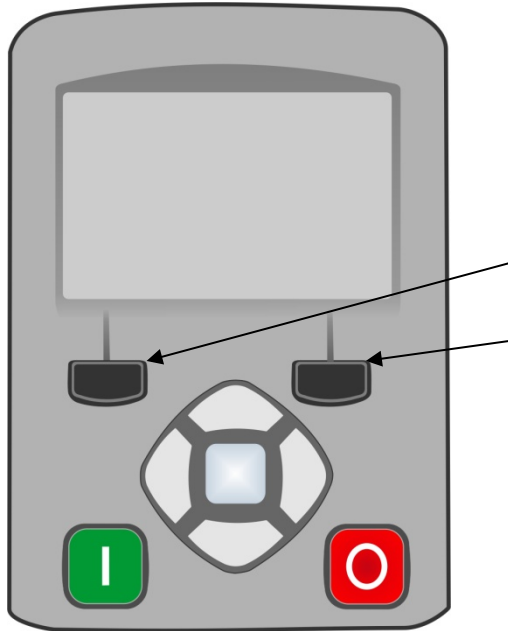

9-2 The Graphical Keypad

Keypad

The GKP has a total of nine keys. They can be divided into three groups:

1. Operation keys (LED illuminated pushbuttons)
2. Soft keys
3. Navigation / Editing keys



Key	Function	
Operating Keys (only active when Local control mode is active)		
	RUN	Runs the inverter.
	STOP	Stops the inverter when running / Resets or Acknowledges trips.
Soft Keys (function changes depending on which screen is displayed)		
	Soft Key 1	Return / Abort / Setup Wizard shortcut
	Soft Key 2	Locks password / Save changes / Toggles between 'Local' or 'Remote' control mode / Changes motor rotation direction ('Local' control mode only) / Add or Removes parameters to or from the 'Favourites' menu.
Navigation / Editing Keys		
	OK	Enters into the next menu level or parameter / Enters into parameter edit mode / Accepts the value of the parameter being edited / Displays parameter information (key press held >1s) / Selects parameter as default at power up (key press held >2s)
	UP	Moves 'up' through the parameters of the menu list / Increments the value of the parameter being edited.
	DOWN	Moves 'down' through the parameters of the menu list / Decrements the value of the parameter being edited.
	LEFT	Moves 'back' to the previous menu list / Selects the digit of the parameter being edited.
	RIGHT	Moves 'into' the next menu list or parameter / Selects the digit of the parameter being edited.

LED Status Indication

The GKP has two LED illuminated pushbuttons – the green ‘Run’ key and the red ‘Stop’ key.
The status of each of these LED illuminated pushbuttons indicates the real time operation of the inverter:

LED Status		Inverter Status:
Run Key	Stop Key	
OFF	ON	STOPPED
ON	OFF	RUNNING
OFF	FLASHING	STOPPING
FLASHING	OFF	AUTO RESTART PENDING
FLASHING (IN SYNC)		NOT IN AN OPERATIONAL STATE
FLASHING (ALTERNATING)		FAULT STATE

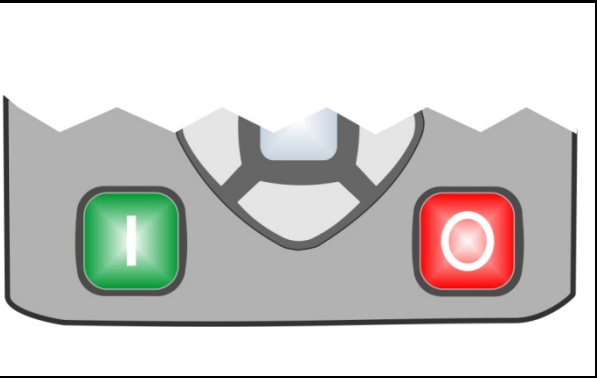
A diagram of the graphical keypad (GKP) showing two illuminated pushbuttons: a green one on the left and a red one on the right. The keypad is grey with a central white area containing a stylized 'V' or 'W' shape. The green key has a vertical bar icon, and the red key has a circle with a diagonal line icon.

Note: The LED operation can be over-ridden by the application.

9-4 The Graphical Keypad

The Display





The display is divided into three areas:

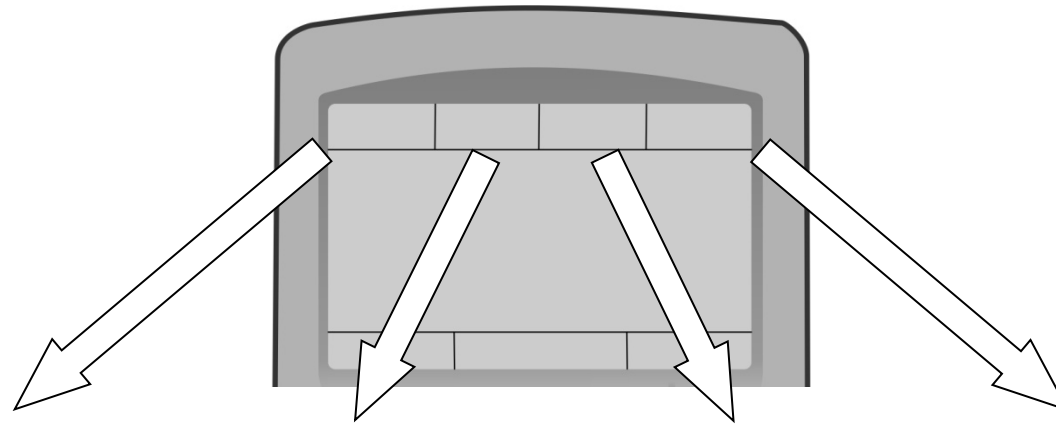

1. Top line: shows a summary of the inverter status.
2. Centre region: is the main work area where menus and parameters are displayed.
3. Bottom line: is used to indicate the action associated with the soft keys.



Top Line - Inverter Status Summary



The top line of the display shows a summary of the inverter status. This is divided into four regions. Each region is dedicated to a particular status indication, as shown.



Run, stop and direction	
Running +ve direction	
Running -ve direction	
Stopped (ready to run in +ve direction)	
Stopped (ready to run in -ve direction)	



Trip	
Inverter Tripped	 (flashing)
Warning	 (solid)
Maintenance required	

Ethernet	
IP address missing	 (flashing)
IP address configured	 (solid)
IP Address configured, PTP clock synchronised	







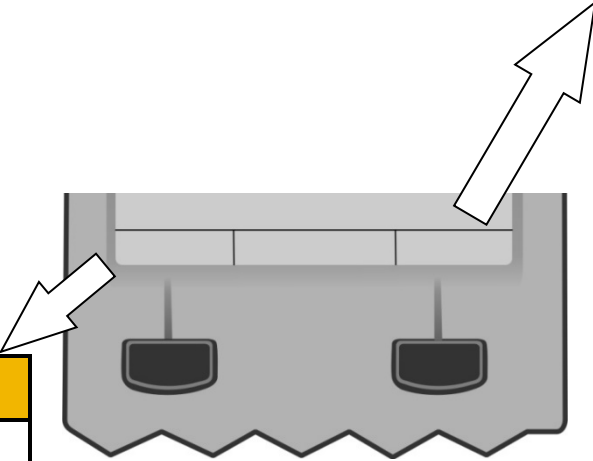

Control Source	
Local: Start / Stop from GKP	
Remote: Start / Stop from control terminals	
Comms: Start / Stop from comms master	

Bottom Line – Soft Key Action Indication

The bottom line of the display indicates the action of the Soft Key 1 and Soft Key 2 pushbuttons, as shown.

Soft Key 1	
<p>Return</p> <p><i>Displayed:</i> when navigating through the menus.</p> <p><i>Soft key action:</i> Moves 'back' to the previous menu level.</p>	
<p>Abort</p> <p><i>Displayed:</i> when editing a parameter value.</p> <p><i>Soft key action:</i> Discards change to parameter value.</p>	
<p>Setup Wizard</p> <p><i>Displayed:</i> when on the GKP welcome page.</p> <p><i>Soft key action:</i> Enters into the setup wizard.</p>	



Soft Key 2	
<p>Lock parameters</p> <p><i>Displayed:</i> when on the GKP welcome page.</p> <p><i>Soft key action:</i> Resets GKP password entered, 'locking' all the parameters.</p>	
<p>Save parameters</p> <p><i>Displayed:</i> when on the GKP welcome page.</p> <p><i>Soft key action:</i> Saves all parameters.</p>	
<p>'Local'/'Remote' control mode</p> <p><i>Displayed:</i> while navigating menus or parameters.</p> <p><i>Soft key action:</i> Toggles between 'Local' and 'Remote' control modes.</p>	
<p>Change direction</p> <p><i>Displayed:</i> while navigating menus or parameters.</p> <p><i>Soft key action:</i> Toggles direction between '+ve' and '-ve' speed setpoint.</p>	
<p>Toggles parameter assigned to 'Soft Key 2'</p> <p><i>Displayed:</i> while navigating menus or parameters.</p> <p><i>Soft key action:</i> Toggles between '0' and '1' control modes. Present value '0'.</p>	
<p>Toggles parameter assigned to 'Soft Key 2'</p> <p><i>Displayed:</i> while navigating menus or parameters.</p> <p><i>Soft key action:</i> Toggles between '0' and '1' control modes. Present value '1'.</p>	
<p>Add to 'Favourites' menu</p> <p><i>Displayed:</i> while viewing parameter attributes.</p> <p><i>Soft key action:</i> Adds parameter to the 'Favourites' menu.</p>	
<p>Remove from 'Favourites' menu</p> <p><i>Displayed:</i> while viewing parameter attributes.</p> <p><i>Soft key action:</i> Removes parameter from the 'Favourites' menu.</p>	

9-6 The Graphical Keypad

The Menu System

Navigating the Menu System

The Menu System can be thought of as a map which is navigated using the direction keys.

- Use the left and right keys to navigate through the menu levels.
- Use the up and down keys to scroll through the Menu and Parameter lists

Menus can contain sub-menus or a list of parameters.

The keys can be used as above to select a parameter. A parameter has a selection, (ie: TRUE / FALSE), or a value displayed below the parameter name.

HINT: Remember that because the Menu and Parameter lists are looped, the UP key can quickly move you to the last Menu or Parameter in the loop. The keys will repeat if you hold them down. This is an easy way to step through and view a menu's contents.

Read-only Parameter Indication

A ':' symbol to the left of the parameter value. indicates that a parameter is read-only.

Changing a Parameter Value

With the parameter you want to change selected, press the center OK key to change to Edit mode. In this mode the arrow keys now perform different functions.

- Change a selection, (i.e. TRUE / FALSE) using the UP and DOWN keys.
- Change a value as follows:
 - The UP and DOWN keys increment / decrement the selected digit.
 - The LEFT and RIGHT keys move the digit selection.
 - The selected digit is indicated by the cursor.

The UP and DOWN keys will repeat if you hold them down.

When changing a value, if the abort icon () is shown over Soft Key 1, pressing this key will abort the edit, leaving the value unchanged.

To accept the edited value, press the center OK key.

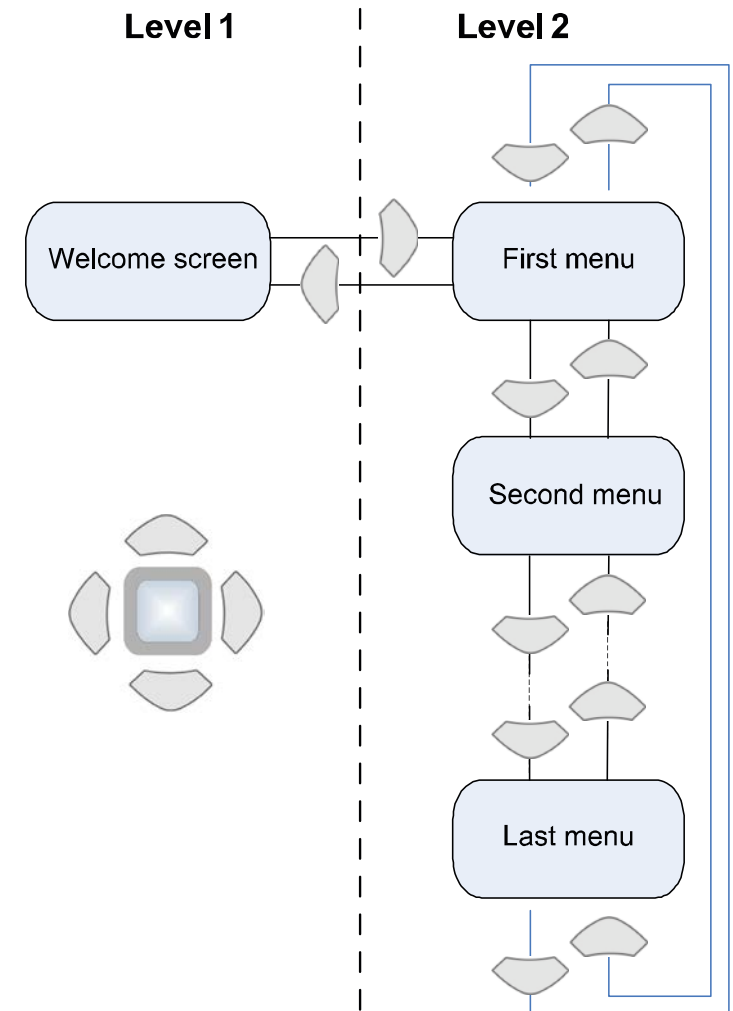

Setup Wizard

The purpose of the Setup Wizard is to configure the inverter in a clear and concise manner.

Starting the Setup Wizard

The Setup Wizard is automatically invoked when the inverter is reset to factory default settings.

Alternatively, the Setup Wizard may be invoked at any other time by navigating to the 'Welcome Screen' at the top of the menu tree and pressing Soft Key 1, as shown by the Setup Wizard ≡ indicator.

Note: It is always recommended that the Setup Wizard is completed once started. Do not interrupt the power when the Wizard is in progress.

Navigating the Setup Wizard

At each step of the Setup Wizard, pressing the OK key selects the displayed value and also moves on to the next step.

Pressing Soft Key 1 moves back a step.

Pressing the UP and DOWN keys modifies the parameter value.

Note: Accepting each choice without change by pressing OK will result in no change to the inverter's configuration.

Setup Wizard Stages

The Setup Wizard starts by asking what user view level is required for the GKP, followed by a list of languages for which the user selects their preference.

The user will then be asked if they would like to continue and run the Wizard. If 'yes', the first option is to "Set Factory Defaults". Changing this parameter to TRUE then pressing OK resets all parameters back to the default value determined by the inverters hardware configuration. In most case, this is recommended. If this choice is left FALSE the setup wizard starts with all parameters with their previously set values.

The rest of the Setup Wizard consists of several sections, each of which corresponds to a functional component of the inverter, for example:

- Application selection
- IO Option, (includes the Encoder)
- Analog input and output ranges.
- Motor Data
- Motor Control
- Fieldbus options
- On-board Ethernet
- Auto tune

If not required, any section may be skipped.

The default setting for all parameters depends on earlier answers and on the physical configuration of the inverter. All data entered is automatically saved without the need for any additional commands.

Finalising Setup

Once the Setup Wizard has been run to completion, the feature is automatically disabled. Power cycling to the inverter will not cause the Setup Wizard to be run again, though If this is required, this can be achieved as detailed above in 'Starting the Setup Wizard'.

Note: For more detailed explanations and information about drive operation and functionality, refer to 'HA503711U003 – AC30 Series Software Reference Manual'.

9-8 The Graphical Keypad

Firmware Update

The inverter firmware will need to be updated in order to take advantage of new product features, bug fixes or new hardware support. To do this:

Prepare the SD card

Download the latest AC30 firmware from the Parker website:

http://divapps.parker.com/divapps/eme/EME/downloads/EME_Software.htm

Alternatively, the latest firmware can be copied through the Parker Drive Quicktool (PDQ), using the 'Drive Maintenance' task.

Copy the firmware onto an SD card. The file must be named **firmware.30x** for the AC30V, or **firmware.30p** for the AC30P/D/A.

Install the SD card

Insert the SD card into the slot in the upper moulding of the control module.

Refer to 'Chapter 5: Installation – Control Module' for details.

Perform the Firmware upgrade

With the SD card installed in the AC30 control module, navigate to the 'Setup Wizard' as detailed on page 9-6. There will now be an additional 'Update Firmware' step as the user goes through the Setup Wizard process.

To start the update, change the value from FALSE to TRUE. The 'Firmware Update In Progress' message will appear, followed by an egg timer.

CAUTION: DO NOT REMOVE POWER FROM THE INVERTER DURING THE FIRMWARE UPDATE.

The inverter will restart once the process is complete and return to the normal menu screen.

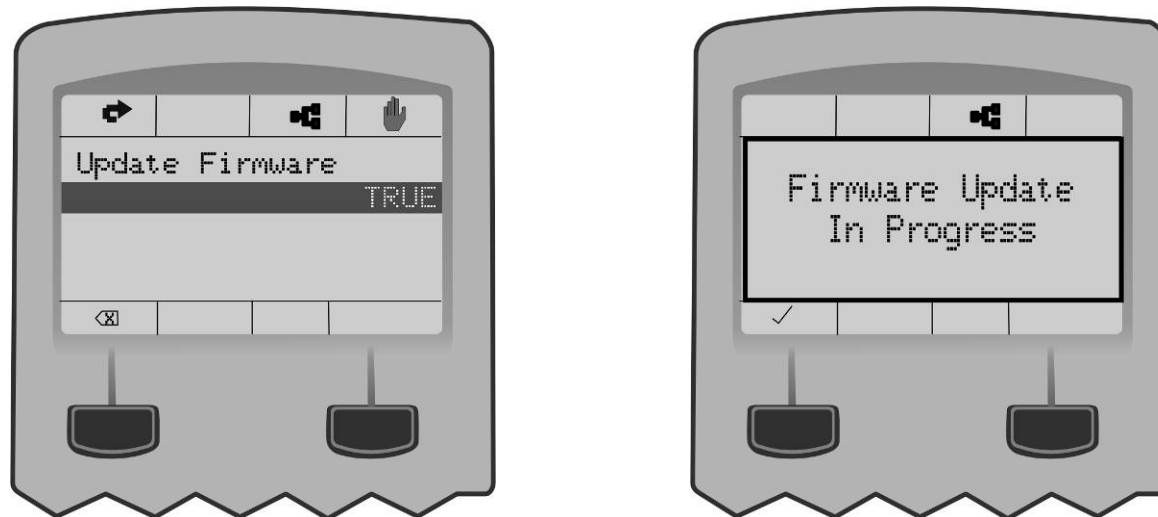

Chapter 10: Routine Maintenance & Repair

Routine Maintenance

Periodically inspect the inverter for build-up of dust obstructions that may affect or ventilation of the unit. Remove this using dry air.

Preventative Maintenance

MAIN DUCT FANS

The power stack cooling fans are designed to be field replaceable by a competent person. For preventative maintenance replace the fan cassette every 5 years of operation, or whenever the inverter trips on 'heatsink overtemperature' under normal operation.

Spare fan cassettes are available to order from your local Parker sales office:

Frame Size	Product Code	Fan Assembly Part No.		
		Qty	IP20	IP55
D	710-4D0004...	-	N/A	N/A
	710-4D0006...	-	N/A	N/A
	710-4D0010...	1	LA501683-1	LA503042-1
	710-4D0012...	1	LA501683-1	LA503042-1
E	710-4E0016...	1	LA501683-1	LA503042-1
	710-4E0023...	1	LA501684-1	LA503042-1
F	710-4F0032...	2	LA501683-1	LA503042-1
	710-4F0038...	2	LA501683-1	LA503042-1
	710-4F0045...	2	LA501684-1	LA503042-1
G	710-4G0045...	2	LA502429-1	LA503649-1
	710-4G0060...	2	LA502287-1	LA503044-1
	710-4G0073...	2	LA502287-1	LA503044-1
H	710-4H0087...	2	LA502429-1	LA503649-1
	710-4H0105...	2	LA502287-1	LA503044-1
	710-4H0145...	2	LA502287-1	LA503044-1
J	710-4J0180...	3	LA502560-1	LA503045-1
	710-4J0205...	3	LA502560-1	LA503045-1
	710-4J0260...	3	LA502560-1	LA503045-1

10-2 Routine Maintenance & Repair

Fan Cassette Replacement Instructions (Frame D)

1. Remove the 2x fan guard retaining screws (closest to the chassis tray) and lift off. The fan is fixed to the guard so it will come away with it too.
2. On fan removal, disconnect the wiring.
3. Remove the 2x fan guard fixing screws from the fan.
4. With the new fan pointing the correct way up (arrow should point up), refit the fan guard to the top of the fan. These fixings should be hand tight.
5. Reconnect and refit the fan and guard assembly and tighten the screws to 1.3Nm.

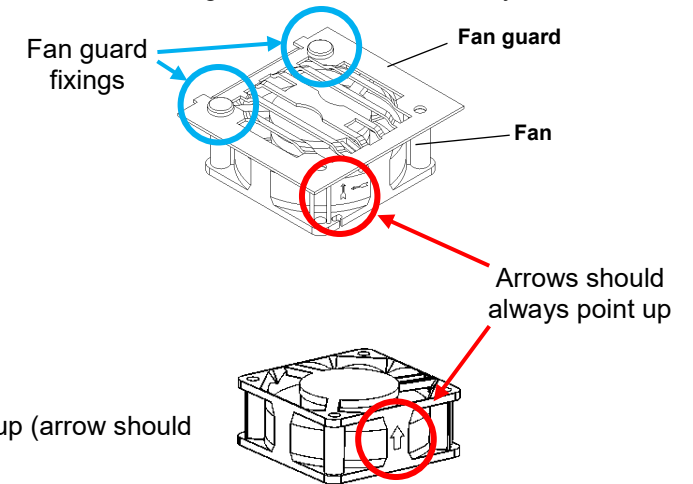

Fan Cassette Replacement Instructions (Frames E – J)

1. Remove the 2x fan guard retaining screws (4x Frame J) and lift off.
2. Lift out the fan(s), disconnecting the wiring on removal.
3. Replace and reconnect the new fan(s) making sure that they are fitted the correct way up (arrow should point up).
4. Refit the fan guard and tighten the screws to 1.3Nm.

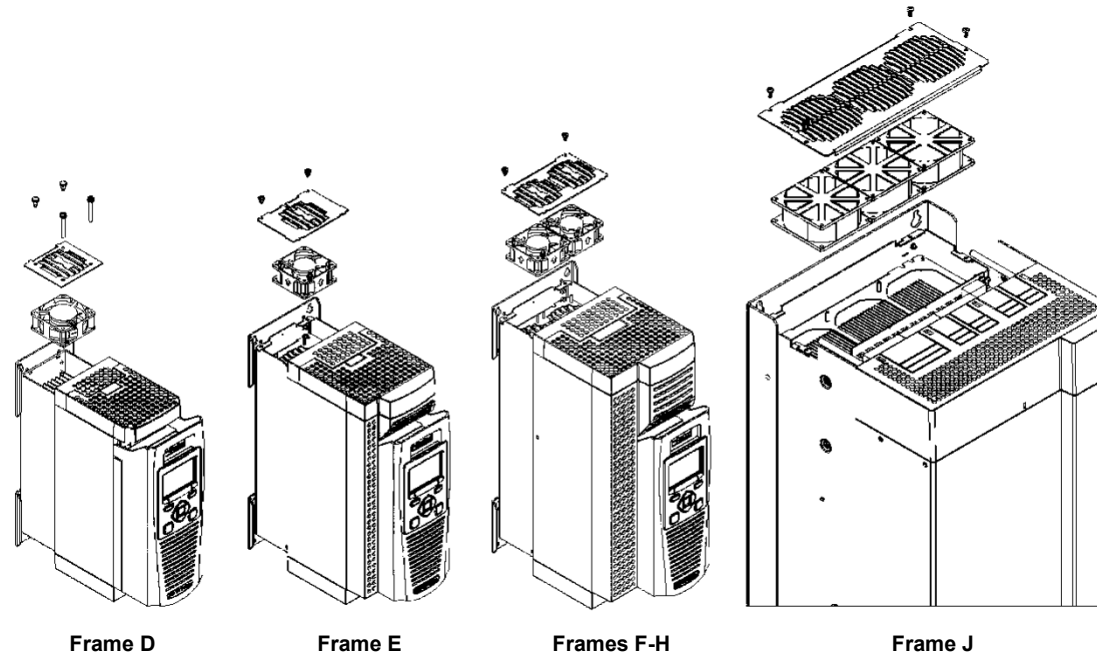

DC LINK CAPACITORS

For preventative maintenance the DC link capacitors must be replaced every 10 years operation, or when the inverter trips on 'DC link ripple' under normal operating conditions. The unit must be returned to your local Parker sales office for replacement.

Repair

There are no user-serviceable components. Only Parker trained personnel are permitted to repair this product to maintain certifications, reliability and quality levels.

IMPORTANT *MAKE NO ATTEMPT TO REPAIR THE UNIT - RETURN IT TO PARKER*

SAVING YOUR APPLICATION DATA

In the event of a repair, application data will be saved whenever possible. However, we advise you to backup your application settings before returning the unit.

RETURNING THE UNIT TO PARKER

Please have the following information available:





- The model and serial number - see the unit's rating label
- Detailed information on the nature of the fault as well as a full description of the application and history. This is important to ensure Parker can diagnose to root cause before return.

Contact your nearest please contact your local Parker Service Center to arrange return of the item and to be given a Authorisation To Return (ATR) number. Use this as a reference on all paperwork you return with the faulty item. Pack and despatch the item in the original packing materials; or at least an anti-static enclosure. Do not allow packaging chips to enter the unit. Please include the fault information described above.

10-4 Routine Maintenance & Repair

Appendix A: Compliance

This Chapter outlines the compliance requirements and product certifications.

	Attention Hot Surfaces		DANGER Risk of electric shock		Caution Refer to documentation		Earth/Ground Protective Conductor Terminal
---	----------------------------------	---	---	---	--	---	---

APPLICABLE STANDARDS

EN 61800-3:2004-A1:2012	Adjustable speed electrical power drive systems – Part 3: EMC requirements and specific test methods.
EN 61800-5-1:2007	Adjustable speed electrical power drive systems – Part 5-1: Safety requirements – Electrical, thermal and energy.
EN 61800-5-2:2007	Adjustable speed electrical power drive systems – Part 5-2: Safety requirements – Functional.
EN ISO 13849-1:2008	Safety of machinery – Safety-related parts of control systems – Part 1: General principles for design.
EN 60204-1:2006+A1:2009	Safety of machinery – Electrical equipment of machines – Part 1: General requirements.
EN 61000-3-2:2014	Electromagnetic Compatibility (EMC) - Part 3-2: Limits – Limits for harmonic current emissions (equipment input current up to and including 16A per phase).
EN62061:2005 Annex E	Safety of machinery – Functional safety of safety related electrical, electronic and programmable electronic control systems.
IEC 61000-3-12:2011	Electromagnetic compatibility (EMC) – Part 3-12: Limits – Limits for harmonic currents produced by equipment connected to public low-voltage systems with input currents >16A and ≤75A per phase.
EN 61000-6-2:2005	Electromagnetic compatibility (EMC) – Part 6-2: General standards – Immunity for industrial environments.
EN 61000-6-3:2007+A1:2011	Electromagnetic compatibility (EMC) – Part 6-3: General standards - Emission standard for residential, commercial and light-industrial environments.
EN 61000-6-4:2007+A1:2011	Electromagnetic compatibility (EMC) – Part 6-4: General standards – Emission standard for residential, commercial and light-industrial environments.
UL508C	Standard for Safety, Power Conversion Equipment, third edition.
CSA 22.2 No.274	Adjustable speed drives.
NFPA	National Electrical Code, National Fire Protection Agency, Part 70.
DNV GL	Rules for Classification of Ships (RU-SHIP), Offshore Units (RU-OU), High Speed & Light Aircraft (RU-HSLC).

EUROPEAN COMPLIANCE

CE MARKING



The CE marking is placed upon the product by Parker Hannifin Manufacturing Ltd to facilitate its free movement within the European Economic Area (EEA). The CE marking provides a presumption of conformity to all applicable directives. Harmonized standards are used to demonstrate compliance with the essential requirements laid down in those relevant directives.

It must be remembered that there is no guarantee that combinations of compliant components will result in a compliant system. This means that compliance to harmonised standards will have to be demonstrated for the system as a whole to ensure compliance with the directive.



Local wiring regulations always take precedence.
Where there are any conflicts between regulatory standards for example earthing requirements for electromagnetic compatibility, safety shall always take precedence.

Low Voltage Directive

When installed in accordance with this manual the product will comply with the low voltage directive 2014/35/EU.



Protective Earth (PE) Connections

Only one protective earth  conductor is permitted at each protective earth terminal contacting point. Unless local wiring states otherwise, the minimum PE earth conductor should be as follows:

Cross-sectional area of phase conductors 'S' (mm ²)	Minimum cross-sectional area of PE conductor 'S _P ' (mm ²)
$S \leq 16$	S
$16 < S \leq 35$	16
$35 < S$	S / 2

Values in table assume PE conductor is the same material as the phase conductors.

In addition to the values in this table, the protective earth conductor cross section area must be at least 10mm² (copper Cu conductor).

EMC Directive

When installed in accordance with this manual the product will comply with the electromagnet compatibility directive 2014/30/EU.

The following information is provided to maximise the Electro Magnetic Compatibility (EMC) of VSDs and systems in their intended operating environment, by minimising their emissions and maximising their immunity.

Machinery Directive**WARNING**

When installed in accordance with this manual the product will comply with the machinery directive 2006/42/EC.

This product is classified under category 21 of annex IV as 'logic units to ensure safety functions'.

All instructions, warnings and safety information can be found in 'Chapter 8: Safe Torque Off SIL3/PLe'.

This product is a component to be incorporated into machinery and may not be operated alone. The complete machinery or installation using this equipment may only be put into service when all safety considerations of the Directive are fully implemented.

Particular reference should be made to EN60204-1 (Safety of Machinery - Electrical Equipment of Machines).



A-4 Compliance

EMC COMPLIANCE



WARNING



In a domestic environment, this product may cause radio interference, in which case supplementary mitigation measures may be required.

Definitions

Category C1

PDS (Power Drive System) of rated voltage less than 1000V, intended for use in the first environment

Category C2

PDS (Power Drive System) of rated voltage less than 1000V, which is neither a plug in device nor a movable device and, when used in the first environment, is intended to be installed and commissioned only by a professional.

Note: A professional is a person or an organisation having necessary skills in installing and/or commissioning power drive systems, including their EMC aspects.

Category C3

PDS (Power Drive System) of rated voltage less than 1000V, intended for use in the second environment and not intended for use in the first environment.

Category C4

PDS (Power Drive System) of rated voltage equal to or above 1000V, or rated current equal to or above 400A, or intended for use in complex systems in the second environment.

First Environment

Environment that include domestic premises, it also includes establishments directly connected without transformers to a low-voltage power supply network which supplies buildings used for domestic purposes.

Note: Houses, apartments, commercial premises or offices in a residential building are examples of first environment locations.

Second Environment

Environment that includes all establishments other than those directly connected to a low-voltage power supply network which supplies buildings used for domestic purposes.

Note: Industrial areas, technical areas of any building fed from a dedicated transformer are examples of second environment locations.

EMC Standards

The EMC standards are concerned with two types of emission:

- **Radiated:** Those in the band 30MHz – 1000MHz which radiate into the environment.
- **Conducted:** Those in the band 150kHz – 30MHz which are injected into the supply.

RADIATED EMISSIONS STANDARDS

The standards have common roots (CISPR 11 & CISPR14) so there is some commonality in the test levels applied in different environments.

Standards			Limits*	
Product Specific	Generic		Frequency (MHz)	dB(μ V/m)
EN 61800-3	EN61000-6-3	EN61000-6-4		
Category C1	Equivalent	Not applicable	30 - 230	30
			230 - 1000	37
Category C2	Not applicable	Equivalent	30 - 230	40
			230 - 1000	47
Category C3	These limits have no relationships with the generic standards.		30 - 230	50
			230 - 1000	60
<p>* = Limit has been adjusted for a measurement distance of 10m.</p> <p>For category C1, if the field strength measurement at 10m cannot be made because of high ambient noise levels or for other reasons, the measurement may be made at 3m.</p> <p>If the 3m distance is used, the measurement result obtained shall be normalised to 10m by subtracting 10dB from the result.</p> <p>In this case, care should be taken to avoid near field effects, particularly when the PDS (Power Drive System) is not of an appropriately small size, and at frequencies near 30MHz.</p> <p>When multiple drives are used, 3dB attenuation per drive needs to be added.</p>				

A-6 Compliance

CONDUCTED EMISSIONS STANDARDS

The various standards have common roots (CISPR 11 & CISPR14) so there is some commonality in the test levels applied in different standards and environments.

Standards			Limits			
Product Specific	Generic		Frequency (MHz)	Quasi Peak (dB/μV)	Average (dB/μV)	
EN 61800-3	EN61000-6-3	EN61000-6-4				
Category C1	Equivalent	Not applicable	0.15 - 0.5	66 > 56 [†]	56 > 46 [†]	
			0.5 - 5.0	56	46	
			5.0 - 30.0	60	50	
Category C2	Not applicable	Equivalent	0.15 - 0.5	79	66	
			0.5 - 5.0	73	60	
			5.0 - 30.0	73	60	
Category C3	These limits have no relationships with the generic standards.		I ≤ 100A	0.15 - 0.5	100	90
				0.5 - 5.0	86	76
				5.0 - 30.0	90 > 70 [†]	80 > 60 [†]
			I ≥ 100A	0.15 - 0.5	130	120
				0.5 - 5.0	125	115
				5.0 - 30.0	115	105

[†] = Limit decreases with the Log of frequency for the specified frequency range

RADIATED EMISSIONS - COMPLIANCE OVERVIEW

Standard EN 61800-3	Frame D (1.1kW & 2.2kW)	Frame D (4kW & 5.5kW)	Frame E	Frame F
Radiated Emissions				
Category C1	When mounted inside a cubicle with the required attenuation between:			
	35-100MHz @ 15dB		35-100MHz @ 5dB	30-150MHz @ 20dB
Category C2	When mounted inside a cubicle with the required attenuation between:			
	35-100MHz @ 5dB		No specific enclosure required.	30-150MHz @ 10dB
Category C3	No specific enclosure required.			

Standard EN 61800-3	Frame G	Frame H (45kW)	Frame H (55kW & 75kW)	Frame J
Radiated Emissions				
Category C1	n / a			
Category C2	When mounted inside a cubicle with the required attenuation between:			
	30-1000MHz @ 10dB			
Category C3	No specific enclosure required.			

A-8 Compliance

CONDUCTED EMISSIONS - COMPLIANCE OVERVIEW

Standard EN 61800-3		Frame D (1.1kW & 2.2kW)	Frame D (4kW & 5.5kW)	Frame E	Frame F
Conducted Emissions					
710 Stacks	Category C1	710-4Dxxxx-xN... product codes, with the addition of the recommended external EMC filters and cabling bracket . Maximum motor cable length 5m.		External EMC filter required. See page A-10 for inverter emission plots.	External EMC filter required. See page A-10 for inverter emission plots.
	Category C2	710-4Dxxxx-xF... product codes. Maximum motor cable length 10m.		710-4Exxxx-xF... product codes. Maximum motor cable length 10m.	710-4Fxxxx-xF... product codes. Maximum motor cable length 10m.
		710-4D0004-xN... & 710-4D0006-xN... product codes, with the addition of the recommended external EMC filter and cabling bracket . Maximum motor cable length 50m.	710-4D0010-xN... & 710-4D0012-xN... product codes, with the addition of the recommended external EMC filter . Maximum motor cable length 25m.	710-4Exxxx-xN... product codes, with the addition of the recommended external EMC filter and cabling bracket . Maximum motor cable length 25m.	710-4Fxxxx-xN... product codes with the addition of the recommended external EMC filter and cabling bracket . Maximum motor cable length 25m.
	Category C3 <i>Where I<=100A</i>	710-4D0004-xE... & 710-4D0006-xE... product codes. Maximum motor cable length 25m.	710-4D0010-xE... & 710-4D0012-xE... product codes. Maximum motor cable length 50m.	710-4Exxxx-xE... product codes. Maximum motor cable length 50m.	710-4Fxxxx-xE... product codes. Maximum motor cable length 25m.
		710-4D0004-xN... & 710-4D0006-xN... product codes, with the addition of the recommended external EMC filter . Maximum motor cable length 50m.			710-4Fxxxx-xF... product codes. Maximum motor cable length 50m.
	740 Stacks	Category C3	740-4xxxx-xN... product codes, when supplied by an AC to DC full bridge and required line choke. Maximum motor cable length 50m.		

Conducted emissions solution true for default switching frequency of inverter. Operation at higher switching frequencies will require extra filtering.

Standard EN 61800-3		Frame G	Frame H (45kW)	Frame H (55kW & 75kW)	Frame J
Conducted Emissions					
710 Stacks	Category C1	External EMC filter required. See page A-10 for inverter emission plots.			
	Category C2	710-4Gxxxx-xF... product codes. Maximum motor cable length 10m.	710-4Hxxxx-xF... product codes. Maximum motor cable length 10m.		710-4Jxxxx-xE... product codes, with the addition of the recommended external EMC filter. Maximum motor cable length 25m.
	Category C3 <i>Where I ≤ 100A</i>	710-4Gxxxx-xE... product codes. Maximum motor cable length 50m.	710-4H0087-xE... product codes. Maximum motor cable length 50m.	n / a	n / a
	Category C3 <i>Where I ≥ 100A</i>	n / a	n / a	710-4H0105-xE... & 710-4H0145-xE... product codes. Maximum motor cable length 50m.	710-4Jxxxx-xE... product codes. Maximum motor cable length 50m.
740 Stacks	Category C3	740-4xxxxx-xN... product codes, when supplied by an AC to DC full bridge and required line choke. Maximum motor cable length 50m.			

Conducted emissions solution true for default switching frequency of inverter. Operation at higher switching frequencies will require extra filtering.

For a full list of recommended External EMC filters and Cabling Brackets see 'Chapter 6: Associated Equipment – Power Stack'. All products fitted with an internal C2 filter are supplied with cabling bracket and output ring core included.

WARNING



The drive is suitable for use on both IT and TN supplies when fitted with either the internal filter, or the recommended external EMC filter. However, when used on an IT supply, the filter effectivity is reduced.

For example, if an inverter fitted with an internal C2 filter is on an IT supply, it will now only comply with the higher C3 limits. Refer to 'Chapter 4: Installation – Power Stack' for details on how to remove the Y-cap and VDR disconnects when installing the product on an IT supply.



Where a solution is required that is not met by the AC30 product range offering, unfiltered emissions plots have been provided to allow specialist EMC filter design companies to tailor a design to meet the customer's needs.

A-10 Compliance

Conducted Emissions Profiles (AC supplied unfiltered Products)

Frame D

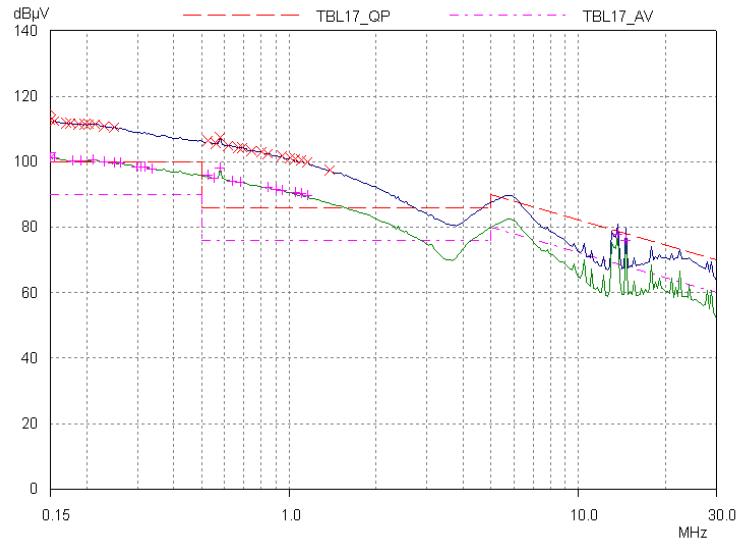

Frame E

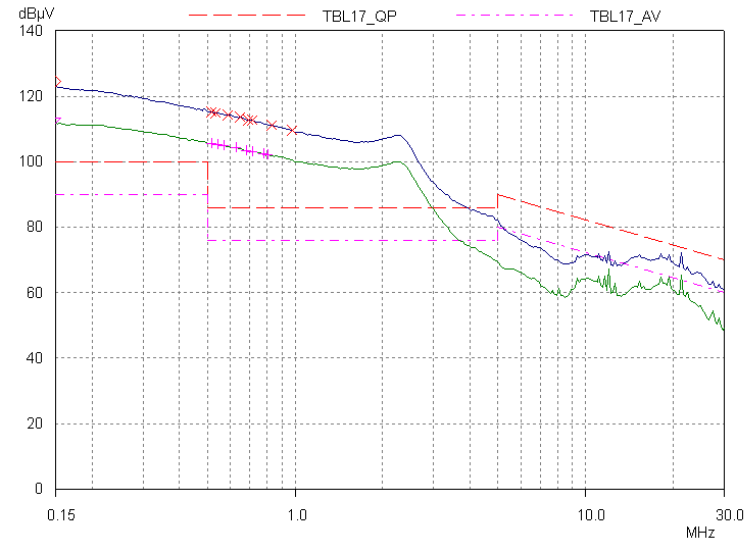

Frame F

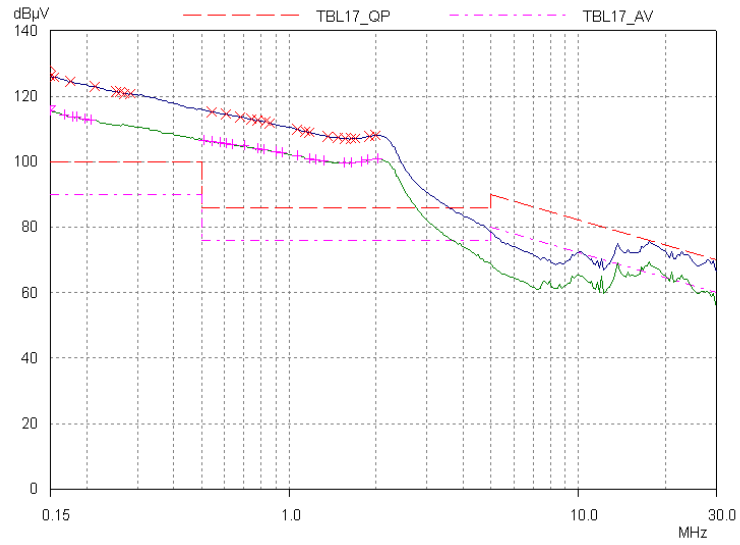

Frame G

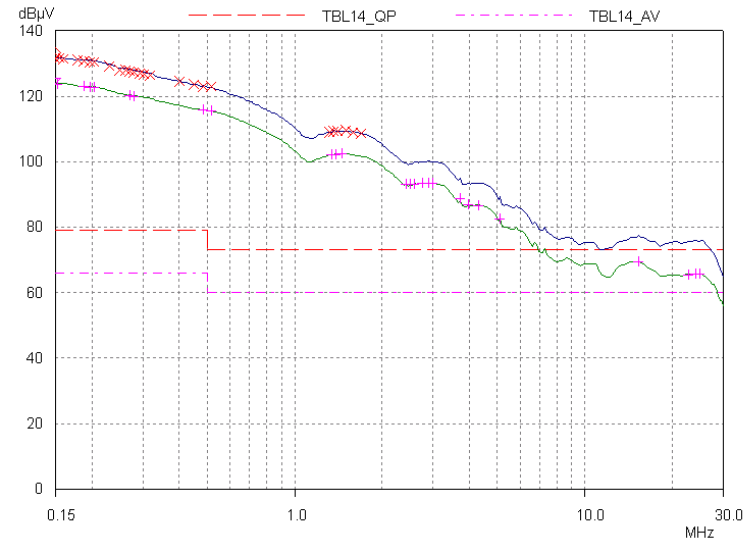

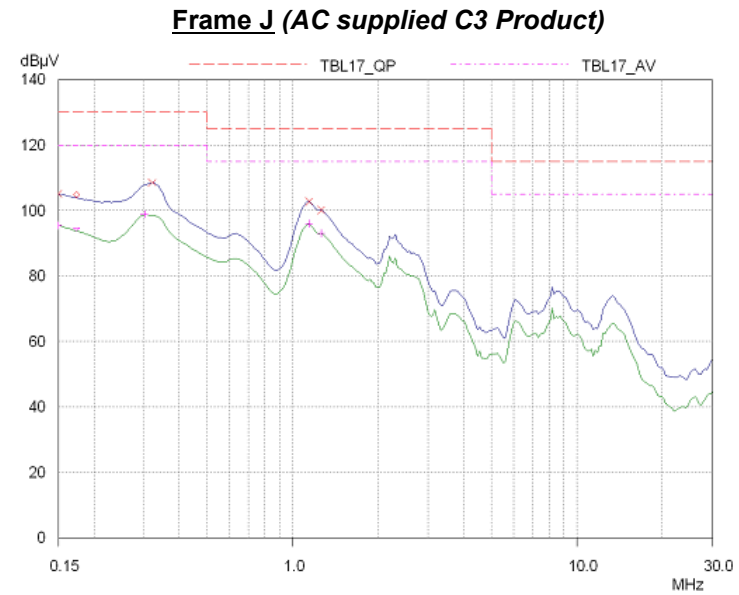
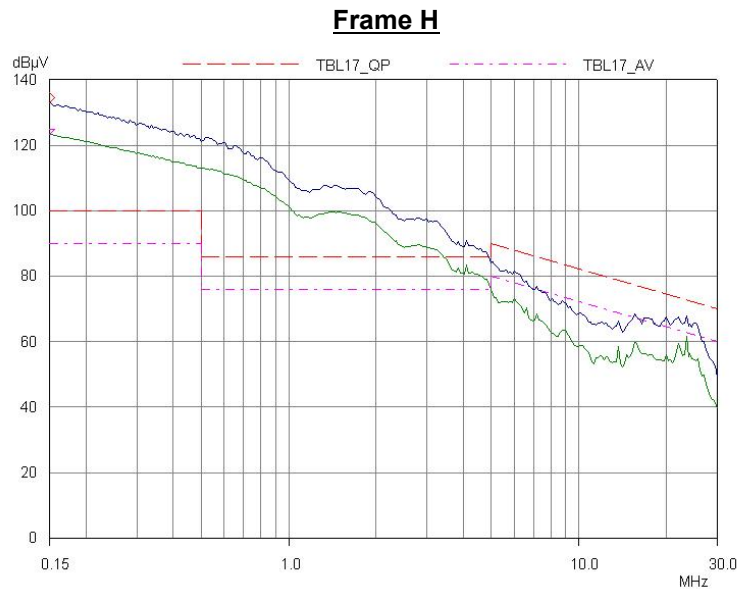

Conducted Emissions Profile (DC supplied unfiltered Products)

Typical common DC bus system emissions (for reference - 800µH AC line choke & 890CS module, supplying two AC30 inverters 740-4D0012 & 740-4E0023)

Note: Actual system emissions will depend on the configuration of the specific application.

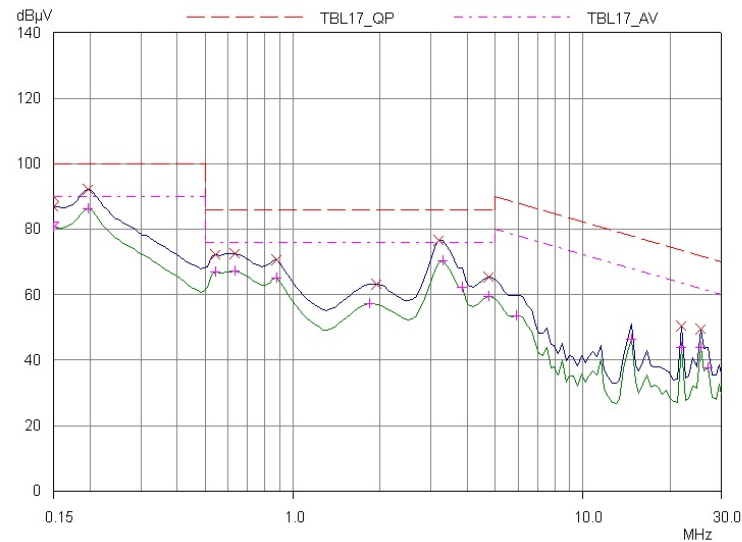

EMC Installation Guidance

PROTECTIVE EARTH (PE) CONNECTIONS



WARNING



Local wiring regulations take precedence and may require the protective earth connection of the motor to be connected locally, i.e. not as specified in these instructions. This will not cause shielding problems because of the relatively high RF impedance of the local earth connection.

Earthing

A star-point earthing policy separates 'noisy' and 'clean' earths. Four separate earth bus bars (three are insulated from the mounting panel) connect to a single earth point (star point) near the incoming safety earth from the main supply:

1. Clean Earth Busbar (insulated from the mounting panel)

Used as a reference point for all signal and control cabling. This may be further subdivided into an analog and a digital reference busbar, each separately connected to the star earthing point. The digital reference is also used for any 24V control.

Control/signal and encoder cables, all analogue inputs, and communications require screening with the screen connected only at the VSD end. However, if high frequency noise is still a problem, earth the screen at the non-VSD end via a 0.1 μ F capacitor. Connect the screen (at the VSD end) to the VSD protective earth point  and not to the control board terminals.

2. Dirty Earth Busbar (insulated from the mounting panel)

Used for all power earths, i.e. protective earth connections. It is also used as a reference for any 110 or 220V control used, and for the control transformer screen.

3. Metal Work Earth Busbar

The back panel is used as this earth busbar, and should provide earthing points for all parts of the cubicle including panels and doors. This busbar is also used for power screened cables which terminate near to (10cm) or directly into a VSD- such as motor cables, braking choppers and their resistors, or between VSDs - refer to the appropriate product manual to identify these. Use U-clips to clamp the screened cables to the back panel to ensure optimum HF connection.

4. Signal/Control Screen Earth Busbar (insulated from the mounting panel)

Used for signal/control screened cables which **do not** go directly to the VSD. Place this busbar as close as possible to the point of cable entry. 'U' clamp the screened cables to the busbar to ensure an optimum HF connection.

Flexible, large cross-section cable is used to ensure low HF impedance. Bus bars are arranged so that the connections to the single earth point is as short as possible.

Example of the earthing of a typical multi-drive system within a cubicle:

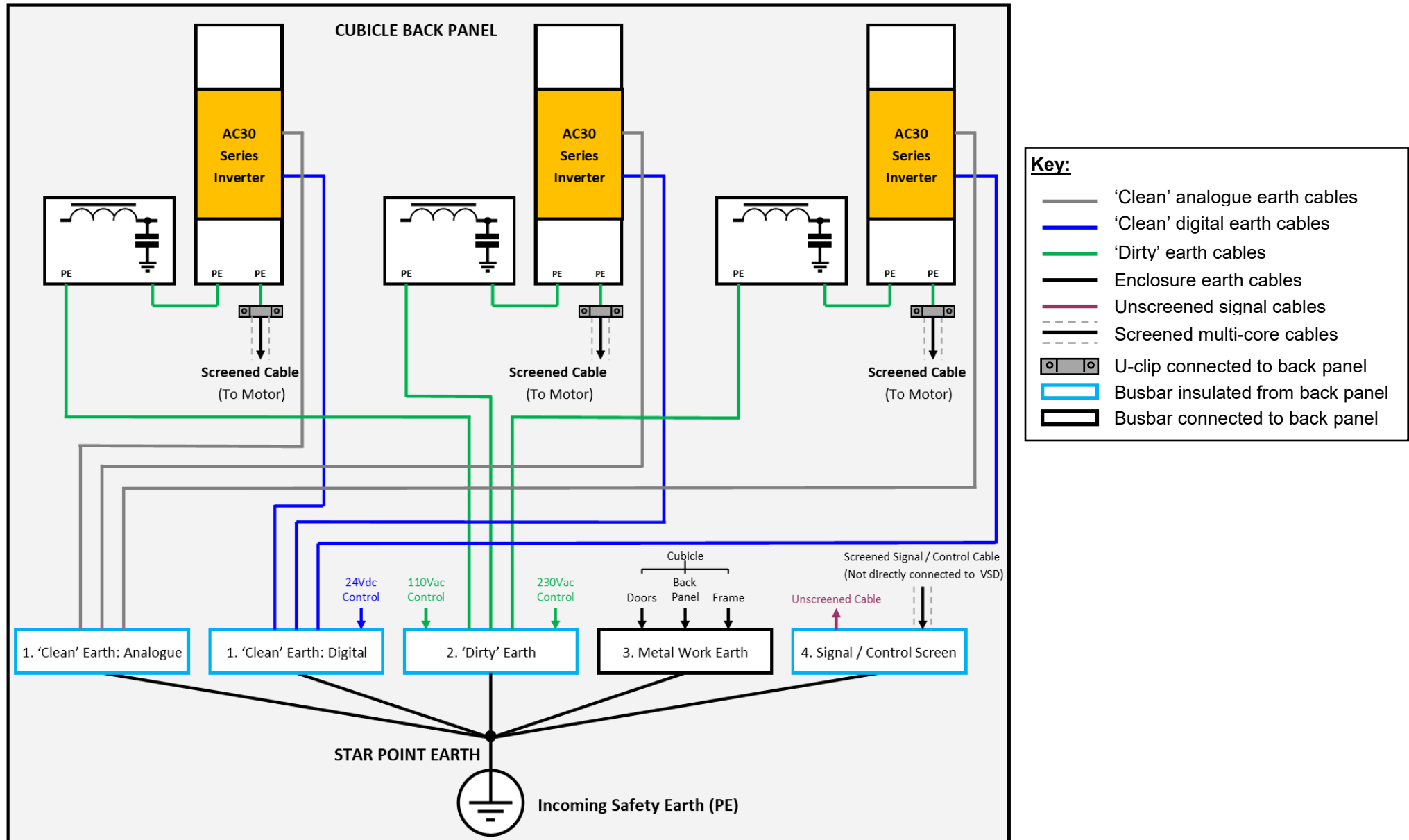

A-14 Compliance

MITIGATING RADIATED EMISSIONS

Equipment Placement

Do not place magnetic/electric field sensitive equipment within 0.25 meters of the following parts of the VSD system:

- Variable Speed Drive (VSD)
- EMC output filters
- Input or output chokes/transformers
- The cable between VSD and motor (even when screened/armored)
- Connections to external braking chopper and resistor (even when screened/armored)
- AC/DC brushed motors (due to commutation)
- DC link connections (even when screened/armored)
- Relays and contactors (even when suppressed)

Emissions from individual components tend to be additive. To reduce the emissions:

- The equipment must be mounted in a metal cubicle. Refer to EMC Compliance Table on page A-7.
- The cubicle should be as free of openings as is practical. Vent systems suitable for EMC applications are available from cubicle vendors and should be used.

Radiated magnetic and electric fields inside the cubicle will be high and any components fitted inside must be sufficiently immune.

- All cable entry and exits (power, control, and communication) should use screened cable
- Earth screen at both ends connecting to the motor frame and cubicle.
- Use of screened/armored cable between VSD/cubicle and motor containing the motor protective earth (PE) connection is most important. If shielded cable is not available, lay unshielded motor cables in a metal conduit which will act as a shield. The conduit must be continuous with a direct electrical contact to the VSD and motor housing. If links are necessary, use **braid** with a minimum cross sectional area of 10mm².
- Use 360° screen terminations.

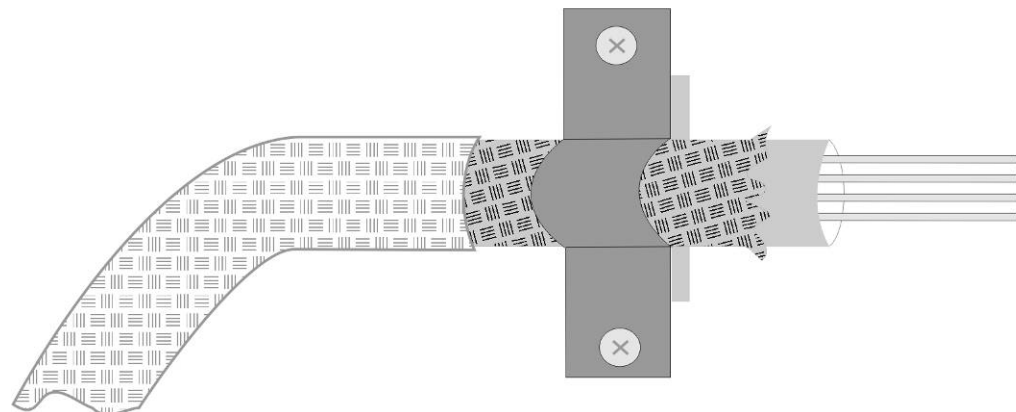

Some hazardous area installations may preclude direct earthing at both ends of the screen, in this case earth one end via a $1\mu\text{F}$ 50Vac capacitor, and the other as normal.

- Keep unshielded cable as short as possible inside the cubicle.
- Always maintain the integrity of the shield. If the cable is interrupted to insert contactors etc., re-connect the screen using the shortest possible route. Some motor gland boxes and conduit glands are made of plastic, if this is the case, then braid must be connected between the screen and the chassis. In addition at the motor end, ensure that the screen is electrically connected to the motor frame since some terminal boxes are insulated from the frame by gasket/paint.
- Keep the length of screen stripped-back as short as possible when making screen connections.

A-16 Compliance

CABLING REQUIREMENTS

Cables are considered to be electrically **sensitive**, **clean** or **noisy**:

AC Line fed 710 power stacks:

- (A)** AC Line Fuses
- (B)** EMC Filter (optional)
- (C)** AC Line Choke (optional)
- (D)** Dynamic Braking Resistor (optional)
- (E)** AC Motor Choke (optional)

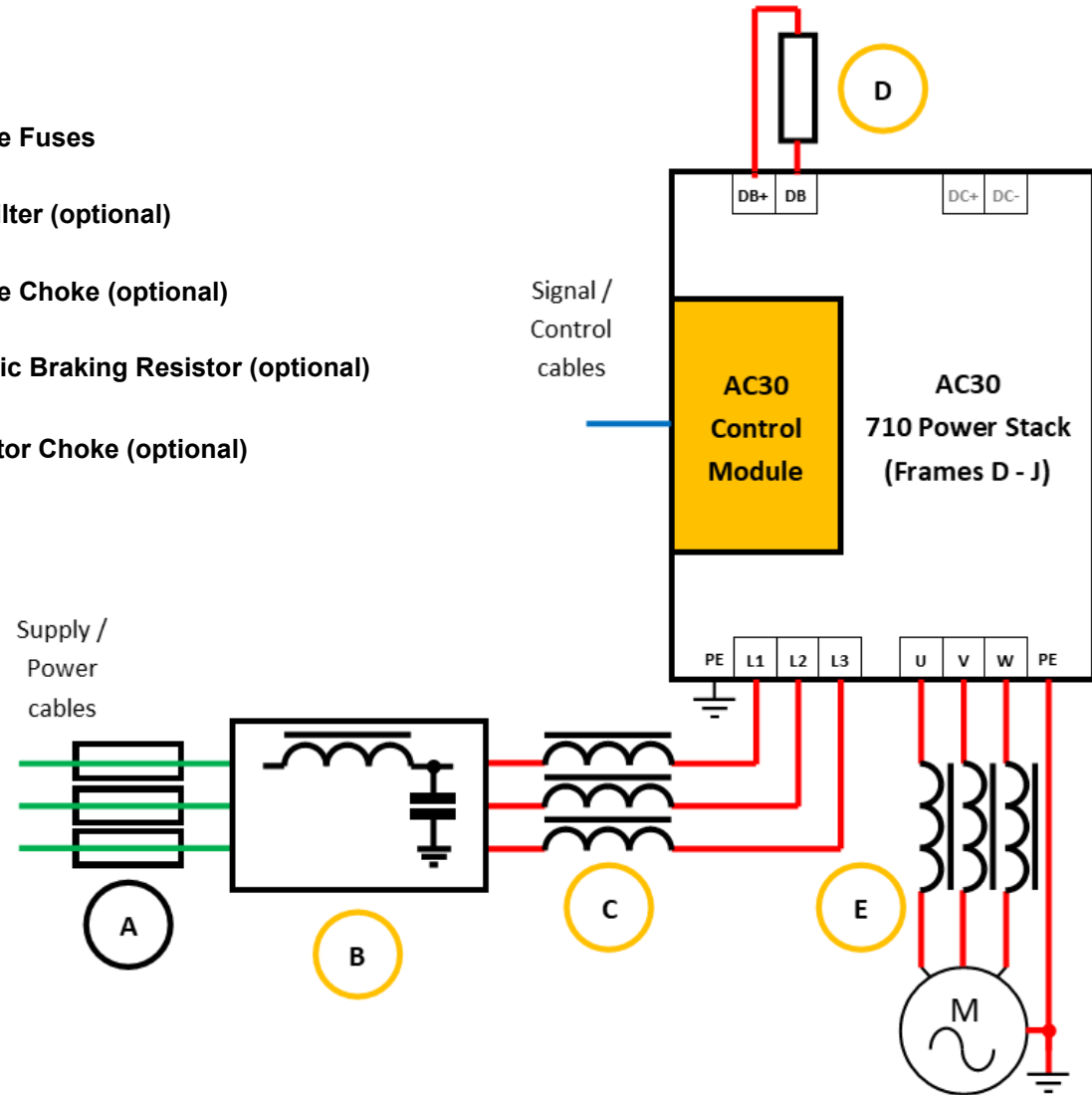
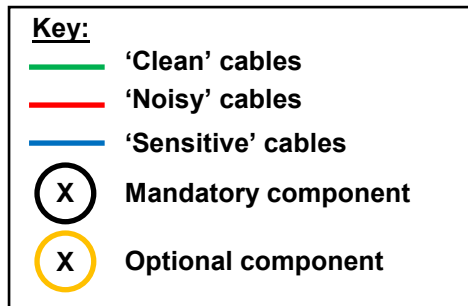

Refer to 'Chapter 6: Associated Equipment – Power Stack' for recommended components to use with the AC30 power stacks.

DC Link fed 740 power stacks:

- (A)** AC Line Fuses
- (B)** EMC Filter (optional)
- (C)** AC Line Choke
Where an 890CS module is used - required
Where an AC30 380 is used - may be required?
- (D)** Dynamic Braking Resistors (optional)
- (E)** DC Link Fuses
- (F)** AC Motor Choke (optional)

380V - 480Vac +/-10%,
50/60Hz, 3 phase supply

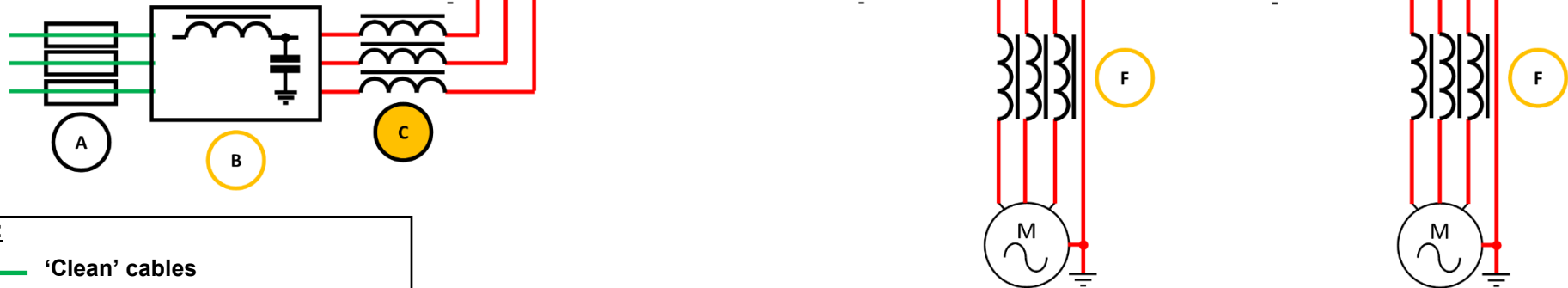

Key:

- 'Clean' cables
- 'Noisy' cables
- 'Sensitive' cables
- (X)** Mandatory component
- (X)** Optional component
- (X)** Component may be required?

Refer to 'Chapter 6: Associated Equipment – Power Stack' for recommended components to use with the AC30 power stacks.

A-18 Compliance

You should already have planned your cable routes with respect to segregating these cables for EMC compliance.

- Use the shortest possible motor cable lengths.
- When connecting multiple motors to a single VSD, use a star junction point for motor cable connections. Use a metal box with entry and exit cable glands to maintain shield integrity.
- Keep electrically noisy and sensitive cables apart.
- Keep electrically noisy and sensitive parallel cable runs to a minimum. Separate parallel cable runs by at least 0.25 meters. For runs longer than 10 meters, separation should be increased proportionally. For example if the parallel runs were 50m, then the separation would be $(50/10) \times 0.25\text{m} = 1.25\text{m}$.
- Sensitive cables should cross noisy cables at 90°.
- Never run sensitive cables close or parallel to the motor, dc link and braking chopper circuit for any distance.
- Never run supply, dc link or motor cables in the same bundle as the signal/control and feedback cables, even if they are screened.
- Ensure EMC filter input and output cables are separately routed and do not couple across the filter.

Cable Requirements	
Power Supply Cable	
Cable Type	Unscreened
Segregation	From all other wiring (clean)
Length Limit	Unlimited
External Filter to Inverter Cable	
Cable Type	Screened / Armoured
Segregation	From all other wiring (noisy)
Length Limit	0.3m
Screen to Earth	Both ends
Motor Cable	
Cable Type	Screened / Armoured
Segregation	From all other wiring (noisy)
Length Limit	50m (up to 300m with an output choke)
Screen to Earth	Both ends
Brake Cable	
Cable Type	Screened / Armoured
Segregation	From all other wiring (noisy)
Length Limit	25m
Screen to Earth	Both ends
Signal / Control Cables	
Cable Type	Screened
Segregation	From all other wiring (sensitive)
Length Limit	25m
Screen to Earth	Inverter end only

Increasing Motor Cable Length

Because cable capacitance and hence conducted emissions increase with motor cable length, conformance to EMC limits is only guaranteed with the specified AC supply filter option up to a maximum cable length as specified on page A-18.

This maximum cable length can be improved using the specified external input or output filters.

Screened/armored cable has significant capacitance between the conductors and screen, which increases linearly with cable length (typically 200pF/m but varies with cable type and current rating).

Long cable lengths may have the following undesirable effects:

- Tripping on 'overcurrent' as the cable capacitance is charged and discharged at the switching frequency.
- Producing increased conducted emissions that degrade the performance of the EMC filter due to saturation.
- Causing RCDs (Residual Current Devices) to trip due to increased high frequency earth current.
- Producing increased heating inside the EMC ac supply filter from the increased conducted emissions.
- These effects can be overcome by adding chokes or output filters at the output of the VSD.

Refer to 'Chapter 6: Associated Equipment – Power Stack' for recommended AC output chokes.

EMC Motor Output Filter

This can help the inverter achieve EMC and filter thermal requirements. It also ensures longer motor life by reducing the high voltage slew rate and overvoltage stresses. Mount the filter as close to the VSD as possible.

Output Contactors

Output contactors can be used, although we recommend that this type of operation is limited to emergency use only or in a system where they are required to provide a means of electrical isolation.

**WARNING**

Ensure that the inverter output is fully quenched before opening or closing the output contactor. Failure to do so can result in damage to the unit.

**External AC Supply EMC Filter**

When an external AC supply EMC filter is required, mount it as close as possible to the drive.

Refer to 'Chapter 6: Associated Equipment – Power Stack' for recommended external EMC filters.

Internal Filter Disconnection

There are separate disconnects for the internal overvoltage suppressors to earth (identified by the label 'VDR') and the internal filter capacitors to earth (identified by the label 'YCAP').

DC supplied inverters do not have overvoltage suppressors to earth.

Refer to 'Chapter 4: Installation – Power Stack' for details on how to disconnect them from earth.

Harmonic Information – AC Supplied Inverters

Supply Harmonic Analysis (Frame D - Normal Duty)

Drive Type = Three Phase, Fundamental Voltage = 400V

Assumptions: Rsce = 120 at 400V where Q_{1n} is the rated rms value of the fundamental voltage of the supply transformer. This product is designated as Professional Equipment for the requirements of EN61000-3-2:2014.

$$THD(V) \times 100 = \frac{\sqrt{\sum_{h=2}^{h=40} Q_{h^2}}}{Q_{1n}} \%$$

Product Code	710-4D0004...	710-4D0006...	710-4D0010...	710-4D0012...
Motor Power (kW)	1.1	2.2	4.0	5.5
Typical Motor Efficiency %	83	83	83	83
Harmonic No.	RMS Current (A)			
1	1.943	3.946	7.078	9.694
3	0.000	0.000	0.001	0.001
5	1.479	2.376	2.852	3.313
7	1.106	1.636	1.673	1.745
9	0.000	0.000	0.000	0.000
11	0.406	0.327	0.594	0.814
13	0.204	0.354	0.445	0.558
15	0.000	0.000	0.000	0.000
17	0.153	0.190	0.345	0.472
19	0.126	0.167	0.257	0.349
21	0.000	0.000	0.000	0.000
23	0.065	0.130	0.236	0.32
25	0.064	0.107	0.184	0.253
27	0.000	0.000	0.000	0.000
29	0.047	0.097	0.175	0.233
31	0.037	0.079	0.142	0.193
33	0.000	0.000	0.000	0.000
35	0.034	0.076	0.135	0.176
37	0.030	0.063	0.114	0.151
39	0.000	0.000	0.000	0.000
40	0.000	0.000	0.000	0.000
Total RMS Current (A)	2.73	4.92	7.87	10.47
* THD (I) %	70.2	59.8	43.7	37.8

* (Total Harmonic Distortion)

Supply Harmonic Analysis (Frame E - Normal Duty)**Drive Type = Three Phase, Fundamental Voltage = 400V**Assumptions: $R_{sce} = 120$ at 400V where Q_{1n} is the rated rms value of the fundamental voltage of the supply transformer.

The 7.5kW product is designated as Professional Equipment for the requirements of EN61000-3-2:2014.

The 11kW product results conform to IEC61000-3-12:2011 (Table 4).

$$THD(V) \times 100 = \frac{\sqrt{\sum_{h=2}^{h=40} Q_h^2}}{Q_{1n}} \%$$

Product Code	710-4E0016...	710-4E0023...
Motor Power (kW)	7.5	11
Typical Motor Efficiency %	83	86
Harmonic No.	RMS Current (A)	
1	12.801	18.703
3	0.002	0.002
5	5.284	6.467
7	3.010	3.425
9	0.000	0.000
11	1.065	1.571
13	0.769	1.078
15	0.000	0.000
17	0.604	0.909
19	0.433	0.669
21	0.000	0.000
23	0.406	0.616
25	0.306	0.484
27	0.000	0.000
29	0.295	0.448
31	0.234	0.370
33	0.000	0.000
35	0.224	0.338
37	0.185	0.290
39	0.000	0.000
40	0.000	0.000
Total RMS Current (A)	14.27	20.24
* THD (I) %	44.2	38.2

* (Total Harmonic Distortion)

A-22 Compliance

Supply Harmonic Analysis (Frame F - Normal Duty)

Drive Type = Three Phase, Fundamental Voltage = 400V Assumptions: Rsce = 120 at 400V where Q_{in} is the rated rms value of the fundamental voltage of the supply transformer. The results conform to IEC61000-3-12:2011 (Table 4).			
	$THD(V) \times 100 = \frac{\sqrt{\sum_{h=2}^{h=40} Q_{h^2}}}{Q_{In}} \%$		
Product Code	710-4F0032...	710-4F0038...	710-4F0045...
Motor Power (kW)	15	18.5	22
Typical Motor Efficiency %	86	86	90
Harmonic No.	RMS Current (A)		
1	25.833	30.954	36.635
3	0.006	0.005	0.013
5	9.512	10.517	12.777
7	5.147	5.527	6.832
9	0.001	0.000	0.001
11	2.177	2.618	3.085
13	1.494	1.781	2.121
15	0.001	0.000	0.001
17	1.244	1.513	1.784
19	0.896	1.110	1.310
21	0.000	0.000	0.000
23	0.838	1.024	1.207
25	0.644	0.803	0.948
27	0.000	0.000	0.000
29	0.608	0.743	0.878
31	0.493	0.613	0.724
33	0.000	0.000	0.000
35	0.459	0.560	0.664
37	0.388	0.480	0.566
39	0.000	0.000	0.000
40	0.000	0.000	0.001
Total RMS Current (A)	28.21	33.41	39.7
* THD (I) %	40.2	37.6	38.5

* (Total Harmonic Distortion)

Supply Harmonic Analysis (Frame G - Normal Duty)**Drive Type = Three Phase, Fundamental Voltage = 400V**Assumptions: Rsce = 120 at 400V where Q_{1n} is the rated rms value of the fundamental voltage of the supply transformer. The results conform to IEC61000-3-12:2011 (Table 4).

$$THD(V) \times 100 = \frac{\sqrt{\sum_{h=2}^{h=40} Q_{h^2}}}{Q_{1n}} \%$$

Product Code	710-4G0045...	710-4G0060...	710-4G0073...
Motor Power (kW)	22	30	37
Typical Motor Efficiency %	90	90	90
Harmonic No.	RMS Current (A)		
1	36.282	49.540	60.995
3	0.003	0.001	0.005
5	12.848	18.710	20.966
7	6.908	10.274	11.144
9	0.000	0.000	0.001
11	3.072	4.174	5.167
13	2.108	2.893	3.533
15	0.000	0.000	0.000
17	1.769	2.382	2.987
19	1.288	1.712	2.188
21	0.000	0.000	0.000
23	1.196	1.604	2.020
25	0.930	1.225	1.583
27	0.001	0.000	0.000
29	0.869	1.162	1.468
31	0.712	0.940	1.211
33	0.001	0.001	0.001
35	0.657	0.882	1.110
37	0.557	0.739	0.946
39	0.001	0.001	0.001
40	0.000	0.000	0.000
Total RMS Current (A)	39.47	54.33	65.95
* THD (I) %	45.7	47.4	43.2

* (Total Harmonic Distortion)

A-24 Compliance

Supply Harmonic Analysis (Frame H - Normal Duty)

Drive Type = Three Phase, Fundamental Voltage = 400V

Assumptions: $R_{sc} = 120$ at 400V where Q_{1n} is the rated rms value of the fundamental voltage of the supply transformer. The results meet the limits specified in IEC61000-3-12:2011 (Table 4).

$$THD(V) \times 100 = \frac{\sqrt{\sum_{h=2}^{h=40} Q_{h^2}}}{Q_{1n}} \%$$

Product Code	710-4H0087...	710-4H0105...	710-4H0145...
Motor Power (kW)	45	55	75
Typical Motor Efficiency %	90	90	90
Harmonic No.	RMS Current (A)		
1	74.18	90.65	123.60
3	0.00	0.00	0.00
5	26.01	31.14	42.31
7	13.92	16.54	22.41
9	0.00	0.00	0.00
11	6.28	7.68	10.47
13	4.30	5.25	7.16
15	0.00	0.00	0.00
17	3.62	4.44	6.05
19	2.64	3.25	4.44
21	0.00	0.00	0.00
23	2.45	3.01	4.10
25	1.91	2.35	3.21
27	0.00	0.00	0.00
29	1.78	2.18	2.98
31	1.46	1.80	2.46
33	0.00	0.00	0.00
35	1.34	1.65	2.25
37	1.14	1.41	1.92
39	0.00	0.00	0.00
40	0.00	0.00	0.00
Total RMS Current (A)	80.43	98.00	133.56
* THD (I) %	41.9	41.1	40.9

* (Total Harmonic Distortion)

Supply Harmonic Analysis (Frame J - Normal Duty)**Drive Type = Three Phase, Fundamental Voltage = 400V**Assumptions: Rsce = 120 at 400V where Q_{1n} is the rated rms value of the fundamental voltage of the supply transformer. The results meet the limits specified in IEC61000-3-12:2011 (Table 4).

$$THD(V) \times 100 = \frac{\sqrt{\sum_{h=2}^{h=40} Q_{h^2}}}{Q_{1n}} \%$$

Product Code	710-4J0180...	710-4J0205...	710-4J0260...
Motor Power (kW)	90	110	132
Typical Motor Efficiency %	92	92	92
Harmonic No.	RMS Current (A)		
1	145	180.9	217.0
3	0.0	0.0	0.0
5	51.0	59.5	70.4
7	27.1	26.4	29.7
9	0.0	0.0	0.0
11	12.2	14.8	17.5
13	8.4	8.9	10.2
15	0.0	0.0	0.0
17	7.0	8.0	9.3
19	5.1	5.5	6.4
21	0.0	0.0	0.0
23	4.8	5.1	5.8
25	3.7	3.9	4.4
27	0.0	0.0	0.0
29	3.5	3.4	3.8
31	2.8	2.8	3.1
33	0.0	0.0	0.0
35	2.6	2.4	2.5
37	2.2	2.1	2.2
39	0.0	0.0	0.0
40	0.0	0.0	0.0
Total RMS Current (A)	157.5	193.4	231.4
* THD (I) %	41.9	37.9	37.1

* (Total Harmonic Distortion)

Requirements for North American and Canadian Compliance

NORTH AMERICAN COMPLIANCE

This product is certified under the US governments Occupational Safety and Health Administration's (OSHA), Nationally Recognised Testing Laboratory (NRTL) program. An NRTL is a private third party organisation accredited by OSHA to test and certify products to national standards for compliance with North American requirements.

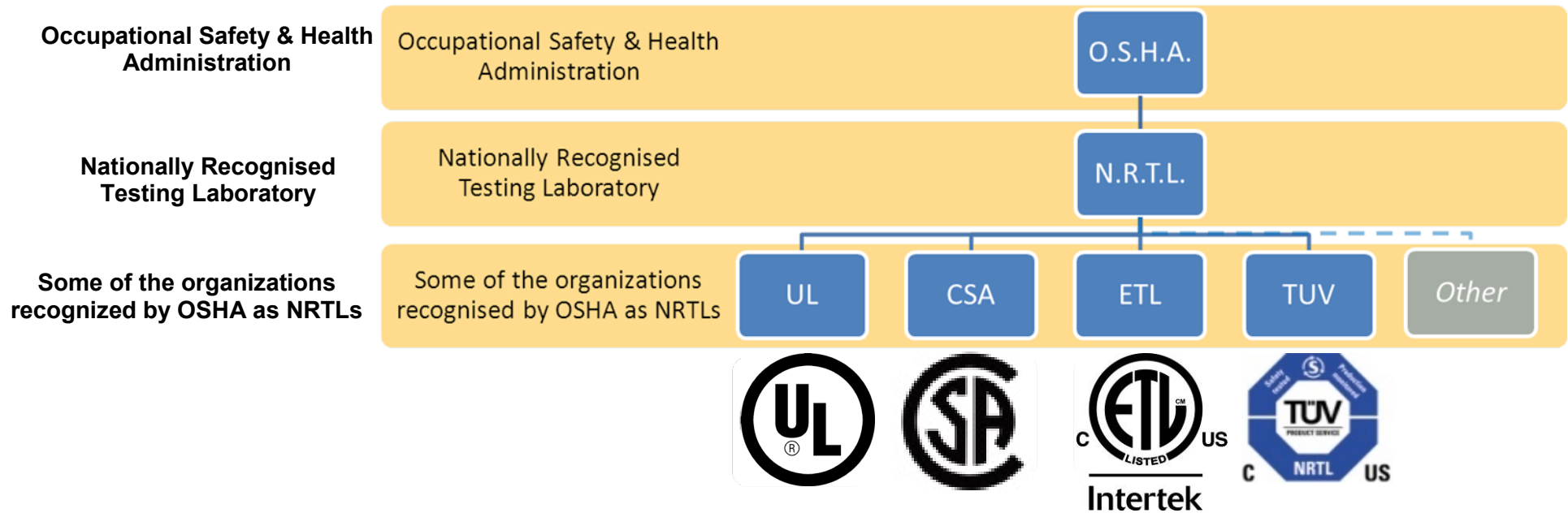

CANADIAN COMPLIANCE

Products have been approved to UL508C - Standard for Safety, Power Conversion Equipment, and to the Canadian Standard CSA 22.2 No. 274 - Adjustable speed drives.

NORTH AMERICAN AND CANADIAN COMPLIANCE INFORMATION

Motor Base Frequency

PMAC and Induction motor modes are identical.

Drive Switching Frequency (kHz)	Maximum Output Frequency (Hz)	Exceptions:
4	500	None.
8	590	1000Hz subject EU Export Control Annex I to Council Regulation (EC) No. 428/2009.
12	590	1500Hz subject EU Export Control Annex I to Council Regulation (EC) No. 428/2009.
16	590	1500Hz subject EU Export Control Annex I to Council Regulation (EC) No. 428/2009.

Drive Protection

Branch Circuit Protection

It is recommended that UL Listed fuses are installed upstream of the drive.

Refer to 'Chapter 6: Associated Equipment – Power Stack' for recommended fuse ratings.

Solid-State Motor Overload Protection

This product provides Class 10 motor overload protection. The maximum internal overload protection level (current limit) is 180% for 3 seconds, in addition Heavy Duty mode is 150% for 60 seconds and Normal Duty mode is 110% for 60 seconds.

Refer to HA503711U003 'Appendix C: Programming' for more information on the current limit operation and user adjustment.

An external motor overload protective device must be provided by the installer where the motor has a full-load Ampere rating of less than 50% of the drive output rating or when the **Disable Stall** trip is enabled; or when the **Stall time** parameter is increased above 480 seconds.

Refer to HA503711U003 'Appendix C: Programming' for more information on the stall trip.

Motor over temperature sensing is not provided by the product unless the external temperature sensor is connected to the motor thermistor input on the GPIO option. When the GPIO option is not fitted an external motor over temperature device is required.

A-28 Compliance

Solid-State Short-Circuit Protection

These devices are provided with integral Solid-State Short-Circuit (output) Protection. Branch circuit protection must be provided in accordance with the latest edition of the National Electrical Code NEC/NFPA-70.

Refer to 'Chapter 6: Associated Equipment – Power Stack' for recommended fuse ratings.

Perspective Short-Circuit Current (PSCC) Supply Ratings

The inverters have been designed to operate on the following PSCC supply ratings:

Frame Size	PSCC Rating (A RMS Symmetrical Amperes, 480V maximum)
D	5,000
E	5,000
F	5,000
G	5,000
H	10,000
J	10,000

Where inverters are to be used on higher rated supplies, refer to 'Chapter 6: Associated Equipment – Power Stack' for recommended AC line chokes.

Field Wiring Temperature Rating

Use minimum 75°C Copper conductors.

Recommended Wire Sizes

North American wire sizes (AWG) are based on NEC/NFPA-70 for ampacities of thermoplastic-insulated (75°C) copper conductors.

The wire sizes allow for an ampacity of 125% of the rated input and output amperes for motor branch-circuit conductors as specified in NEC/NFPA-70.

Refer to 'Chapter 4: Installation – Power Stack' for recommended wire sizes.

Maritime Rules & Standards Compliance

DET NORSKE VERITAS (DNV GL) COMPLIANCE (FRAMES D-H ONLY)

AC30 Frames D-H products are certified to comply with DNV GL rules for classification of Ships, Offshore Units, and High Speed & Light Aircraft.

Vibration Levels

According to the DNV Standard For Certification No. 2.4, “Environmental Test Specification For Instrumentation And Automation Equipment”, the products meet the Class A – General Vibration Strain limits defined in table 3-6:

Frequency Range	Displacement	Acceleration
5Hz to 13.2Hz	1.0mm (peak)	
13.2Hz to 100Hz		0.7g
Sweep rate	max. 1 octave/minute	

In order to comply with the vibration levels, vibration mounts **must** be fitted to the Power Stacks.

For installation information see ‘Chapter 4: Installation – Power Stack’.

For a list of these vibration mount kits, see ‘Chapter 6: Associated Equipment – Power Stack’.

Environmental

RESTRICTION, EVALUATION, AUTHORISATION AND RESTRICTION OF CHEMICALS (REACH)

The Regulation (EC) No 1907/2006 of the European Parliament and of the Council of 18 December 2006 concerning the Registration, Evaluation, Authorization, and Restriction of Chemicals (REACH) entered into force on June 1, 2007. Parker agrees with the purpose of REACH which is to ensure a high level of protection of human health and the environment. Parker is compliant with all applicable requirements of REACH.

The registration requirements do not apply to Parker since it is neither a manufacturer nor an importer of preparations into Europe.

However, product (article) manufacturers or importers into Europe are obligated under Article 33 of REACH to inform recipients of any articles that contain chemicals on the Substances of Very High Concern (SVHC) candidate list above a 0.1% concentration (by weight per article).

Parker will continue to monitor the developments of the REACH legislation and will communicate with our customers according to the requirement above.

RESTRICTION OF HAZARDOUS SUBSTANCES (RoHS)

This product is in full compliance with RoHS Directive 2011/65/EU, with respect to the following substances:

- 1) Lead (Pb),
- 2) Mercury (Hg),
- 3) Cadmium (Cd),
- 4) Hexavalent chromium (Cr (VI)),
- 5) Polybrominated biphenyls (PBB),
- 6) Polybrominated diphenyl ethers (PBDE).

WASTE ELECTRICAL AND ELECTRONIC EQUIPMENT (WEEE)



Waste Electrical and Electronic Equipment - must not be disposed of with domestic waste.
It must be separately collected according to local legislation and applicable laws.



Parker Hannifin Company, together with local distributors and in accordance with EU directive 2012/19/EU, undertakes to withdraw and dispose of its products, fully respecting environmental considerations.

For more information about how to recycle your Parker supplied waste equipment, please contact your local Parker Service Centre.

Packaging

During transport our products are protected by suitable packaging. This is entirely environmentally compatible and should be taken for central disposal as secondary raw material.

Appendix B: E Plan Library

E Plan Library

For information on the E Plan library go to www.eplan.co.uk web site.

To obtain layout diagrams from our E Plan Library go to www.parker.com/eme/ac30 and then click to the drive link.



HOME PRODUCTS MARKETS SUPPORT WHERE TO BUY ABOUT US CONTACT US

Home › Electromechanical and Drives Division Europe › Drives and Inverters › AC Drives and Accessories › AC Drives

AC DRIVES

Parker offers a complete range of AC variable speed drives for a wide variety of applications ranging from 0.2 to 2000 kW. Parker drive solutions range from basic, open-loop industrial applications to advanced, closed-loop process line applications.

SORT BY PRODUCT ATTRIBUTES

SERIES	+
INPUT SUPPLY VOLTAGE RANGE	+
OUTPUT RATING (KW)	+
OPERATING CONTROL MODES	+
COMMUNICATION	-

AC DRIVES (1 - 3 of 3)



AC Variable Frequency Drives, KW Rated - AC30 Series [Complete Drive Pack]

The AC30V variable speed drives provide users with exceptional levels of motor control for general purpose open-loop industrial applications up to 250kW. A range of communications and I/O options are available separately.

B-2 E Plan Library

And then to the tab "Product Support", where you'll find the EPLAN Download link.

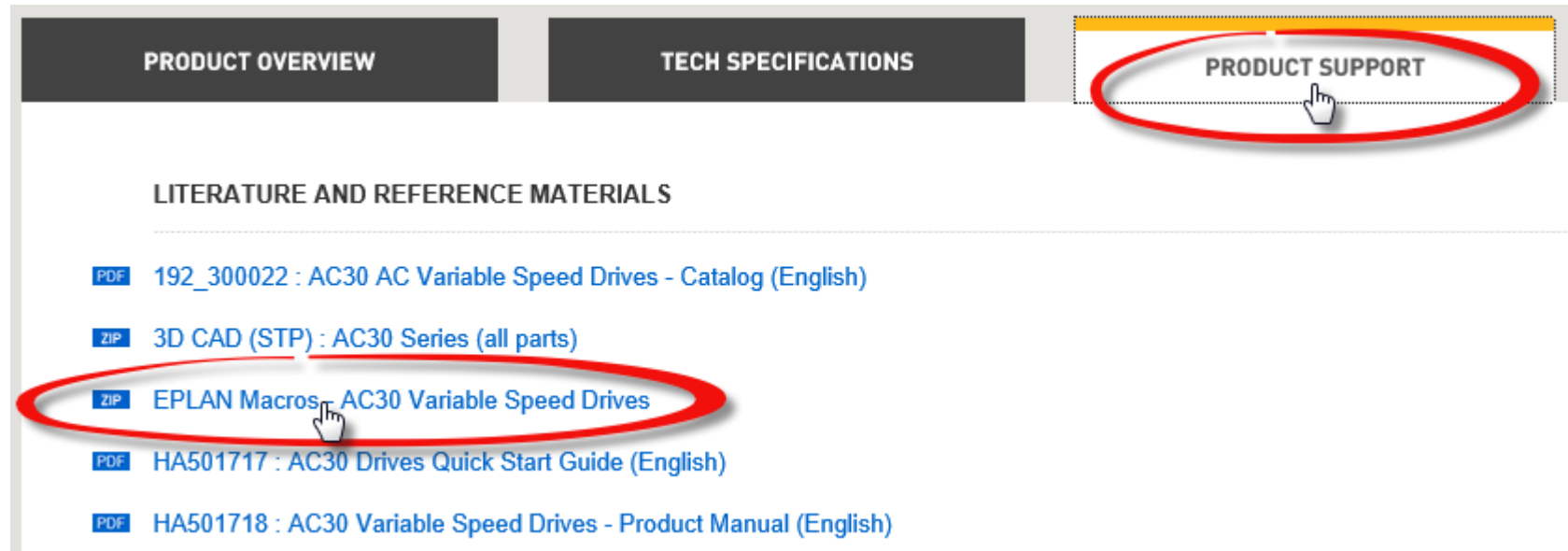

PRODUCT OVERVIEW **TECH SPECIFICATIONS** **PRODUCT SUPPORT**

LITERATURE AND REFERENCE MATERIALS

- [PDF](#) 192_300022 : AC30 AC Variable Speed Drives - Catalog (English)
- [ZIP](#) 3D CAD (STP) : AC30 Series (all parts)
- [ZIP](#) **EPLAN Macros - AC30 Variable Speed Drives**
- [PDF](#) HA501717 : AC30 Drives Quick Start Guide (English)
- [PDF](#) HA501718 : AC30 Variable Speed Drives - Product Manual (English)

Appendix D: AC30 Series Product Codes

Understanding the Product Code

The unit is fully identified using an alphanumeric code. This records how the inverter was calibrated, and its various settings when dispatched from the factory. This can also be referred to as the Product Code.

AC30 SERIES CONTROL MODULE

	1	2		3	4		5
Order example	30	V	-	2	S	-	0000
1	Device Family						
	30	AC30 series control module only (no power stack)					
2	Industry						
	V	Standard controller					
	P	Advanced controller					
	D	Advanced controller with dual encoder system option					
	A	Advanced controller with absolute encoder system option					
3	Graphical Keypad						
	1	Blanking cover fitted					
	2	Graphical keypad fitted					
4	Environmental Coating						
	S	Standard 3C3 coating					
5	Special Options						
	0000	No special options					

Typical example: 30V-2S-0000 (as shown in the “Order example” above).

This shows the product is an AC30 series versatile controller, with Graphical Keypad fitted, standard 3C3 conformal coating and no special options.

Note: This product code is for the control module only. The power stack must be ordered in addition to this (see page D-2).

D-2 AC30 Series Product Codes

AC30 SERIES POWER STACK

	1		2	3		4	5		6	7		8	
Order example	710	-	4	D	0004	-	B	E	-	0	S	-	0000

1	Device Family
710	AC Power stack only (no control module)
740	DC Power stack only (no control module)
2	Voltage
4	400 V nominal supply system (AC line)
3	Frame Size and Current Rating
	(normal / heavy duty)
D0004	1.1 kW / 0.75 kW
D0006	2.2 kW / 1.5 kW
D0010	4 kW / 3 kW
D0012	5.5 kW / 4 kW
E0016	7.5 kW / 5.5 kW
E0023	11 kW / 7.5 kW
F0032	15 kW / 11 kW
F0038	18.5 kW / 15 kW
F0045	22 kW / 18.5 kW
G0045	22 kW / 18.5 kW
G0060	30 kW / 22 kW
G0073	37 kW / 30 kW
H0087	45 kW / 37 kW
H0105	55 kW / 45 kW
H0145	75 kW / 55 kW
J0180	90 kW / 75 kW
J0205	110 kW / 90 kW
J0260	132 kW / 110 kW

3	Frame Size and Current Rating (cont'd)
	(normal / heavy duty)
K0315	160 kW / 132 kW
K0380	200 kW / 160 kW
K0440	250 kW / 200 kW
L0530	280 kW / 250 kW
L0590	315 kW / 280 kW
M0650	355 kW / 315 kW
M0700	400 kW / 355 kW
N0790	450 kW / 400 kW
4	Brake Switch
N	Without brake switch (Frames LMN only)
B	Brake switch fitted (Frames D-K only)
5	EMC Filter ⁽¹⁾
N	No filter fitted
E	Category C3 filter fitted (standard)
F	Category C2 filter fitted (Frames D-H only)
6	Graphical Keypad
0	No keypad fitted
7	Environmental Coating
S	Standard 3C3 coating
8	Special Options
0000	No special options

(1) 1. Only EMC filter option N is valid on 740 products.

2. Only EMC filter option E is valid on Frame sizes K, L, M & N 710 products.

Typical example: 710-4D0004-BE-0S-0000 (as shown in the "Order example" above).

This shows the product is an AC30 series AC line fed Frame D power stack, IP21 standard, rated at 400-480 volts supply, 1.1kW (normal duty), with brake switch fitted, Category C3 EMC filter, no Graphical Keypad fitted, standard 3C3 conformal coating and no special options.

Note: This product code is for the power stack only. The control module must be ordered in addition to this (see page D-1).

CONFIGURED AC30 SERIES INVERTER

Note: Not all configurable order codes are available in all territories.

Order example	1	2		3	4		5	6		7	8		9	
	31	V	-	4	D	0004	-	B	E	-	2	S	-	0000

1	Device Family
31	AC30 series complete AC line fed drive
34	AC30 series complete DC link fed drive
2	Industry
V	Standard controller
P	Advanced controller
D	Advanced controller with dual encoder system option
A	Advanced controller with absolute encoder system option
3	Voltage
4	400 V nominal supply system (AC line)
4	Frame Size and Current Rating
	(normal / heavy duty)
D0004	1.1 kW / 0.75 kW
D0006	2.2 kW / 1.5 kW
D0010	4 kW / 3 kW
D0012	5.5 kW / 4 kW
E0016	7.5 kW / 5.5 kW
E0023	11 kW / 7.5 kW
F0032	15 kW / 11 kW
F0038	18.5 kW / 15 kW
F0045	22 kW / 18.5 kW
G0045	22 kW / 18.5 kW
G0060	30 kW / 22 kW
G0073	37 kW / 30 kW
H0087	45 kW / 37 kW
H0105	55 kW / 45 kW
H0145	75 kW / 55 kW

4	Frame Size and Current Rating (cont'd)
	(normal / heavy duty)
J0180	90 kW / 75 kW
J0205	110 kW / 90 kW
J0260	132 kW / 110 kW
K0315	160 kW / 132 kW
K0380	200 kW / 160 kW
K0440	250 kW / 200 kW
L0530	280 kW / 250 kW
L0590	315 kW / 280 kW
M0650	355 kW / 315 kW
M0700	400 kW / 355 kW
N0790	450 kW / 400 kW
5	Brake Switch
N	Without brake switch (Frames LMN only)
B	Brake switch fitted (Frames D-K only)
6	EMC Filter ⁽¹⁾
N	No filter fitted
E	Category C3 filter fitted (standard)
F	Category C2 filter fitted (Frames D-H only)
7	Graphical Keypad
1	Blanking cover fitted
2	Graphical keypad fitted
8	Environmental Coating
S	Standard 3C3 coating
9	Special Options
0000	No special options

(1) 1. Only EMC filter option N is valid on 740 products.

2. Only EMC filter option E is valid on Frame sizes K, L, M & N 710 products.

Typical example: 31V-4D004-BE-2S-0000 (as shown in the "Order example" above).

This shows the product is an AC30 series AC line fed Frame D inverter with versatile controller, IP21 standard, rated at 400-480 volts supply, 1.1kW (normal duty), with brake switch fitted, Category C3 EMC filter, with Graphical Keypad fitted, standard 3C3 conformal coating and no special options.

Note: This product code is for a complete AC30V series drive (includes both control module and power stack).

D-4 AC30 Series Product Codes

AC30 SERIES REGENERATIVE SUPPLY UNIT

	1		2	3		4	5		6
Order example	380	-	5	R 0094	-	N	E	-	0000

1	Device Family
380	AC30 series regenerative supply unit
2	Voltage
5	400 V - 500 V nominal
3	Frame Size and Current Rating
	Output drive current rating / Nominal driving power @ 500V
R0094	94 A / 60 kW
R0157	157 A / 100 kW
S0251	251 A / 160 kW
S0394	394 A / 250 kW
S0536	536 A / 340 kW

4	Brake Switch
N	Without brake switch (standard)
5	EMC Filter
E	Category C3 compliant (standard)
6	Special Options
0000	No special options

Typical example: 380-5R0094-NE-0000 (as shown in the "Order example" above).

This shows the product is an AC30 series regenerative supply unit, rated at 400-500 volts supply, 94A output current rating – 60kW @ 500V, without a brake switch fitted, Category C3 compliant and no special options.

Appendix E: Technical Specifications - Power Stack

ENVIRONMENTAL DETAILS

Operating Temperature	<p>Operating temperature is defined as the surrounding air temperature of the drive, when the drive and other equipment adjacent to it is operating at worst case conditions.</p> <p>NORMAL DUTY (ND): 0°C to 40°C, derate up to a maximum of 50°C</p> <p>HEAVY DUTY (HD): 0°C to 45°C, derate up to a maximum of 50°C</p> <p>Output power is derated linearly at 2% per degree centigrade for temperature exceeding the maximum rating for the drive.</p>	
Storage Temperature	-25°C to +55°C	
Shipping Temperature	-25°C to +70 °C	
Product Enclosure Rating	Cubicle Mounted	IP20 – remainder of surfaces (Europe) UL (c-UL) Open Type (North America/Canada)
	Through-panel Mounted	IP20 – remainder of surfaces (Europe) UL (c-UL) Open Type (North America/Canada)
	Note: With frame sizes H & J, in order to retain the IP20 rating when making use of the DC-bus terminals, only partly remove DC-bus terminal cover breakouts or use additional external guarding.	
Altitude	If greater than 1000m above sea level, derate by 1% per 100m to a maximum of 2000m	
Humidity	Maximum 85% relative humidity at 40°C non-condensing	
Atmosphere	Non flammable, non corrosive and dust free	
Climatic Conditions	Class 3k3, as defined by EN60721-3-3	
Chemically Active Substances	<p>For the standard product (which inherently includes our optimal level of conformal coating) compliance with EN60721-3-3 is as follows –</p> <p>a) Both classes 3C3 and 3C4 for hydrogen sulphide gas (H₂S) at a gas concentration of 25ppm for 1200 hours.</p> <p>b) Both classes 3C1 (rural) and 3C2 (urban) for all nine defined substances as defined in table 4.</p> <p>Classes 3C1 and 3C2 are valid for both storage and transportation purposes.</p> <p>Note: Product was tested and validated with a hydrogen sulphide environment of 25ppm for a continuous period of 1200 hours and validated throughout the test period without failure.</p>	
Vibration	<p>Test Fc of EN60068-2-6</p> <p>10Hz<=f<=57Hz sinusoidal 0.075mm amplitude</p> <p>57Hz<=f<=150Hz sinusoidal 1g</p> <p>10 sweep cycles per axis on each of three mutually perpendicular axis</p>	

E-2 Technical Specifications - Power Stack

SAFETY DETAILS

Overvoltage Category	Overvoltage Category III (numeral defining an impulse withstand level)
Pollution Degree	Pollution Degree II (non-conductive pollution, except for temporary condensation) for control electronics Pollution Degree III (dirty air rating) for through-panel mounted parts
North America/Canada	Complies with the requirements of UL508C as an open-type drive.

EARTHING DETAILS

Earthing	Permanent earthing is mandatory on all units. <ul style="list-style-type: none">• Use a copper protective earth conductor 10mm² minimum cross-section, or install a second conductor in parallel with the protective conductor to a separate protective earth terminal• The conductor itself must meet local requirements for a protective earth conductor
Input Supply Details (TN) and (IT)	Drives without filters are suitable for earth referenced (TN) or non-earth referenced (IT) supplies. The drive is only suitable for earth referenced supplies (TN) when fitted with an internal filter. External filters are available for use on TN and IT (non-earth referenced) supplies. Not suitable for TN corner earthed distribution systems.
Prospective Short Circuit Current (PSCC)	Refer to the appropriate Electrical Ratings table.
Earth Leakage Current	>10mA (all models)

COOLING FANS

The forced-vent cooling of the drive is achieved by 1, 2 or in some cases 3 fans. The fan flow rate given in the table is the per fan volume of air specified on the part datasheet.

Frame Size	Product Code	Fan Flow Rates				
		Duct Fan			Internal Fan	
		Qty	IP20	IP55	Qty	-
D	7x0-4D0004...	-	N/A	N/A	-	N/A
	7x0-4D0006...	-	N/A	N/A		
	7x0-4D0010...	1	27 (45)	32 (54)		
	7x0-4D0012...	1	27 (45)	32 (54)		
E	7x0-4E0016...	1	27 (45)	32 (54)	-	N/A
	7x0-4E0023...	1	33 (56)	32 (54)		
F	7x0-4F0032...	2	27 (45)	32 (54)	-	N/A
	7x0-4F0038...	2	27 (45)	32 (54)	-	N/A
	7x0-4F0045...	2	33 (56)	32 (54)	1	5 (8.5)
G	7x0-4G0045...	2	42.5 (71)	42.5 (71)	1	27 (45)
	7x0-4G0060...	2	84 (143)	84 (143)		
	7x0-4G0073...	2	84 (143)	84 (143)		
H	7x0-4H0087...	2	42.5 (71)	42.5 (71)	1	27 (45)
	7x0-4H0105...	2	84 (143)	84 (143)		
	7x0-4H0145...	2	84 (143)	84 (143)		
J	7x0-4J0180...	3	120 (204)	120 (204)	2	27 (45)
	7x0-4J0205...	3	120 (204)	120 (204)		
	7x0-4J0260...	3	120 (204)	120 (204)		

All fan flow rates specified in cfm (m³/hr)

E-4 Technical Specifications - Power Stack

AC FED ELECTRICAL RATINGS

Power Supply = 380-480V ±10%, 50/60Hz ±5%, PSCC = 5kA

Motor power, output current and input current must not be exceeded under steady state operating conditions.

Minimum repetitive power up / power down cycle time = 10 mins.

Frame Size	Product Code	400V, 50Hz AC input ratings			460V, 60Hz AC input ratings			Est. Eff (%)	Switching Frequency (kHz) nom / max	Output Current Derate (%/kHz)
		Motor Power (kW)	Output Current (A)	Input Current (A)	Motor Power (hp)	Output Current (A)	Input Current (A)			
D	Normal Duty (Output Overload Motoring 110% for 60s)									
	710-4D0004...	1.1	3.5	4	1.5	3.0	3.5	95	4 / 16	2.4
	710-4D0006...	2.2	5.5	7.6	3	4.8	6.4	96	4 / 16	4.5
	710-4D0010...	4	10.0	8	5	7.6	6.6	97	4 / 16	3.9
	710-4D0012...	5.5	12.0	10.6	7.5	11	9.4	97	4 / 16	3.5
	Heavy Duty (Output Overload Motoring 150% for 60s, 180% for 3s short term rating)									
	710-4D0004...	0.75	2.5	2.9	1	2.1	2.4	95	4 / 16	1.0
	710-4D0006...	1.5	4.5	5.3	2	3.4	4.5	96	4 / 16	4.3
	710-4D0010...	3	7.5	6.5				97	4 / 16	3.8
	710-4D0012...	4	10.0	8	5	7.6	6.6	97	4 / 16	3.3
E	Normal Duty (Output Overload Motoring 110% for 60s)									
	710-4E0016...	7.5	16	14.5	10	14	12.1	97	4 / 16	5.5
	710-4E0023...	11	23	20.4	15	21	18	97	4 / 16	5.1
	Heavy Duty (Output Overload Motoring 150% for 60s, 180% for 3s short term rating)									
	710-4E0016...	5.5	12	10.7	7.5	11	9.5	97	4 / 16	4.9
710-4E0023...	7.5	16	14.5	10	14	12.7	97	4 / 16	4.9	

Technical Specifications - Power Stack E-5

Power Supply = 380-480V ±10%, 50/60Hz ±5%, PSCC = 5kA

Motor power, output current and input current must not be exceeded under steady state operating conditions.

Minimum repetitive power up / power down cycle time = 10 mins.

Frame Size	Product Code	400V, 50Hz AC input ratings			460V, 60Hz AC input ratings			Est. Eff (%)	Switching Frequency (kHz) nom / max	Output Current Derate (%/kHz)
		Motor Power (kW)	Output Current (A)	Input Current (A)	Motor Power (hp)	Output Current (A)	Input Current (A)			
F	Normal Duty (Output Overload Motoring 110% for 60s)									
	710-4F0032...	15	32	28.5	20	27	24.5	97	4 / 12	6.3
	710-4F0038...	18.5	38	33.5	25	36	30.2	97	4 / 12	6.7
	710-4F0045...	22	45	40	30	40	35.7	97	3 / 12	6.7
	Heavy Duty (Output Overload Motoring 150% for 60s, 180% for 3s short term rating)									
	710-4F0032...	11	23	21.7	15	21	19.1	97	4 / 12	6.0
	710-4F0038...	15	32	28.5	20	27	24.5	97	4 / 12	6.1
710-4F0045...	18.5	38	34.3	25	36	30.5	97	3 / 12	6.1	

Power Supply = 380-480V ±10%, 50/60Hz ±5%, PSCC = 10kA

Motor power, output current and input current must not be exceeded under steady state operating conditions.

Minimum repetitive power up / power down cycle time = 10 mins

Frame Size	Product Code	400V, 50Hz AC input ratings			460V, 60Hz AC input ratings			Est. Eff (%)	Switching Frequency (kHz) nom / max	Output Current Derate (%/kHz)
		Motor Power (kW)	Output Current (A)	Input Current (A)	Motor Power (hp)	Output Current (A)	Input Current (A)			
G	Normal Duty (Output Overload Motoring 110% for 60s)									
	710-4G0045...	22	45	40	30	40	35.7	98	3 / 12	5.7
	710-4G0060...	30	60	54.7	40	52	48	98	3 / 12	5.9
	710-4G0073...	37	73	66.2	50	65	58.5	98	3 / 12	5.6
	Heavy Duty (Output Overload Motoring 150% for 60s, 180% for 3s short term rating)									
	710-4G0045...	18	38	34.3	25	36	30.5	98	3 / 12	5.3
	710-4G0060...	22	45	41.8	30	40	37.5	98	3 / 12	5.7
710-4G0073...	30	60	54.7	40	52	48	98	3 / 12	5.2	

E-6 Technical Specifications - Power Stack

Power Supply = 380-480V ±10%, 50/60Hz ±5%, PSCC = 10kA

Motor power, output current and input current must not be exceeded under steady state operating conditions.

Minimum repetitive power up / power down cycle time = 10 mins

Frame Size	Product Code	400V, 50Hz AC input ratings			460V, 60Hz AC input ratings			Est. Eff (%)	Switching Frequency (kHz) nom / max	Output Current Derate (%/kHz)
		Motor Power (kW)	Output Current (A)	Input Current (A)	Motor Power (hp)	Output Current (A)	Input Current (A)			
H	Normal Duty (Output Overload Motoring 110% for 60s)									
	710-4H0087...	45	87	78.8	60	77	69	98	2.5 / 9	7.7
	710-4H0105...	55	105	95.8	75	96	84.5	98	2.5 / 9	7.1
	710-4H0145...	75	145	130	100	124	113.5	98	2.5 / 9	8.3
	Heavy Duty (Output Overload Motoring 150% for 60s, 180% for 3s short term rating)									
	710-4H0087...	37	73	66	50	65	58.5	98	2.5 / 9	7.0
	710-4H0105...	45	87	79.5	60	77	70	98	2.5 / 9	6.3
	710-4H0145...	55	105	97.4	75	96	87	98	2.5 / 9	7.8
	J	Normal Duty (Output Overload Motoring 110% for 60s)								
710-4J0180...		90	180	160	125	156	147	98	2.5 / 8	8.1
710-4J0205...		110	205	198	150	180	175	98	2.5 / 8	8.4
710-4J0260...		132	260	236	200	240	231	98	2.5 / 8	8.7
Heavy Duty (Output Overload Motoring 150% for 60s, 180% for 3s short term rating)										
710-4J0180...		75	145	137	100	124	119	98	2.5 / 8	7.5
710-4J0205...		90	180	164	125	156	148	98	2.5 / 8	8.6
710-4J0260...		110	205	199	150	180	177	98	2.5 / 8	8.0

DC FED ELECTRICAL RATINGS

Power Supply = 510V - 650V DC average, AC line choke equivalent to 4%

Motor power, output current and input current must not be exceeded under steady state operating conditions.

Frame Size	Product Code	530V DC input ratings			620V DC input ratings			Est. Eff (%)	Switching Frequency (kHz) nom / max	Output Current Derate (%/kHz)	
		Motor Power (kW)	Output Current (A)	Input Current (A)	Motor Power (hp)	Output Current (A)	Input Current (A)				
D	Normal Duty (Output Overload Motoring 110% for 60s)										
		740-4D0004...	1.1	3.5	3.5	1.5	3.0	3.1	95	4 / 16	2.4
		740-4D0006...	2.2	5.5	6.3	3	4.8	5.6	96	4 / 16	4.5
		740-4D0010...	4	10.0	9.8	5	7.6	8.1	97	4 / 16	3.9
		740-4D0012...	5.5	12.0	13.0	7.5	11	11.5	97	4 / 16	3.5
	Heavy Duty (Output Overload Motoring 150% for 60s, 180% for 3s short term rating)										
		740-4D0004...	0.75	2.5	2.5	1	2.1	2.2	95	4 / 16	1.0
		740-4D0006...	1.5	4.5	4.6	2	3.4	3.9	96	4 / 16	4.3
		740-4D0010...	3	7.5	7.7				97	4 / 16	3.8
		740-4D0012...	4	10.0	9.8	5	7.6	8.1	97	4 / 16	3.3
E	Normal Duty (Output Overload Motoring 110% for 60s)										
		740-4E0016...	7.5	16	18	10	14	15	97	4 / 16	5.5
		740-4E0023...	11	23	25	15	21	22	97	4 / 16	5.1
	Heavy Duty (Output Overload Motoring 150% for 60s, 180% for 3s short term rating)										
		740-4E0016...	5.5	12	13	7.5	11	12	97	4 / 16	4.9
	740-4E0023...	7.5	16	18	10	14	16	97	4 / 16	4.9	

E-8 Technical Specifications - Power Stack

Power Supply = 510V - 650V DC average, AC line choke equivalent to 4%										
Motor power, output current and input current must not be exceeded under steady state operating conditions.										
Frame Size	Product Code	530V DC input ratings			620V DC input ratings			Est. Eff (%)	Switching Frequency (kHz) nom / max	Output Current Derate (%/kHz)
		Motor Power (kW)	Output Current (A)	Input Current (A)	Motor Power (hp)	Output Current (A)	Input Current (A)			
F	Normal Duty (Output Overload Motoring 110% for 60s)									
	740-4F0032...	15	32	35	20	27	30	97	4 / 12	6.3
	740-4F0038...	18.5	38	41	25	36	37	97	4 / 12	6.7
	740-4F0045...	22	45	49	30	40	46	97	3 / 12	6.7
	Heavy Duty (Output Overload Motoring 150% for 60s, 180% for 3s short term rating)									
	740-4F0032...	11	23	27	15	21	23	97	4 / 12	6.0
	740-4F0038...	15	32	35	20	27	30	97	4 / 12	6.1
	740-4F0045...	18.5	38	41	25	36	37	97	3 / 12	6.1
	G	Normal Duty (Output Overload Motoring 110% for 60s)								
740-4G0045...		22	45	49	30	40	46	98	3 / 12	5.7
740-4G0060...		30	60	67	40	52	59	98	3 / 12	5.9
740-4G0073...		37	73	81	50	65	72	98	3 / 12	5.6
Heavy Duty (Output Overload Motoring 150% for 60s, 180% for 3s short term rating)										
740-4G0045...		18	38	42	25	36	37	98	3 / 12	5.3
740-4G0060...		22	45	51	30	40	46	98	3 / 12	5.7
740-4G0073...		30	60	67	40	52	59	98	3 / 12	5.2

Technical Specifications - Power Stack E-9

Power Supply = 510V - 650V DC average, AC line choke equivalent to 4%

Motor power, output current and input current must not be exceeded under steady state operating conditions.

Frame Size	Product Code	530V DC input ratings			620V DC input ratings			Est. Eff (%)	Switching Frequency (kHz) nom / max	Output Current Derate (%/kHz)
		Motor Power (kW)	Output Current (A)	Input Current (A)	Motor Power (hp)	Output Current (A)	Input Current (A)			
H	Normal Duty (Output Overload Motoring 110% for 60s)									
	740-4H0087...	45	87	97	60	77	85	98	2.5 / 9	7.7
	740-4H0105...	55	105	117	75	96	104	98	2.5 / 9	7.1
	740-4H0145...	75	145	159	100	124	139	98	2.5 / 9	8.3
	Heavy Duty (Output Overload Motoring 150% for 60s, 180% for 3s short term rating)									
	740-4H0087...	37	73	81	50	65	72	98	2.5 / 9	7.0
	740-4H0105...	45	87	97	60	77	86	98	2.5 / 9	6.3
	740-4H0145...	55	105	119	75	96	107	98	2.5 / 9	7.8
	J	Normal Duty (Output Overload Motoring 110% for 60s)								
740-4J0180...		90	180	198	125	156	180	98	2.5 / 8	8.1
740-4J0205...		110	205	243	150	180	214	98	2.5 / 8	8.4
740-4J0260...		132	260	289	200	240	283	98	2.5 / 8	8.7
Heavy Duty (Output Overload Motoring 150% for 60s, 180% for 3s short term rating)										
740-4J0180...		75	145	168	100	124	146	98	2.5 / 8	7.5
740-4J0205...		90	180	201	125	156	181	98	2.5 / 8	8.6
740-4J0260...		110	205	244	150	180	217	98	2.5 / 8	8.0

E-10 Technical Specifications - Power Stack

AFE MODE ELECTRICAL RATINGS

Power Supply = 380-480V \pm 10%, 50/60Hz \pm 5%

Ratings must not be exceeded under steady state operating conditions.

Minimum repetitive power up / power down cycle time = 10 mins

Frame Size	Product Code	400V, 50Hz AC supply ratings			460V, 60Hz AC supply ratings			Est. Eff (%)	Switching Frequency (kHz) nom / max	AC Current Derate (%/kHz)
		AFE Rating (kVA)	Rated AC Current (A)	Rated DC Current (A)	AFE Rating (kVA)	Rated AC Current (A)	Rated DC Current (A)			
Heavy Duty (Overload 150% for 60s, 180% for 3s short term rating)										
D	740-4D0004...	1.7	2.5	3.1	1.7	2.1	2.6	98	4 / 16	1.0
	740-4D0006...	3.1	4.5	5.6	2.7	3.4	4.2	98	4 / 16	4.3
	740-4D0010...	5.2	7.5	9.4				98	4 / 16	3.8
	740-4D0012...	6.9	10.0	12.5	6.1	7.6	9.5	98	4 / 16	3.3
E	740-4E0016...	8.3	12	15	8.8	11	13.7	98	4 / 16	4.9
	740-4E0023...	11.1	16	20	11.2	14	17.5	98	4 / 16	4.9
F	740-4F0032...	15.9	23	28.7	16.7	21	26.2	98	4 / 12	6.0
	740-4F0038...	22.2	32	40	21.5	27	33.7	98	4 / 12	6.1
	740-4F0045...	26.3	38	47.5	28.7	36	45	98	3 / 12	6.1
G	740-4G0045...	26.3	38	47.2	28.7	36	44.8	98.5	3 / 12	5.3
	740-4G0060...	31.2	45	56.0	31.9	40	49.7	98.5	3 / 12	5.7
	740-4G0073...	41.6	60	74.6	41.4	52	64.7	98.5	3 / 12	5.2
H	740-4H0087...	50.6	73	90.8	51.8	65	80.8	98.5	2.5 / 9	7.0
	740-4H0105...	60.3	87	108.2	61.3	77	95.7	98.5	2.5 / 9	6.3
	740-4H0145...	72.7	105	130.6	76.5	96	119.4	98.5	2.5 / 9	7.8
J	740-4J0180...	100.5	145	179.4	98.8	124	153.4	99	2.5 / 8	7.5
	740-4J0205...	124.7	180	222.7	124.3	156	193	99	2.5 / 8	8.6
	740-4J0260...	142	205	253.6	143.4	180	222.7	99	2.5 / 8	8.0

INTERNAL DYNAMIC BRAKE SWITCH

DC link brake voltage = 765V										
Frame Size	Product Code	Motor Power		Peak Operation [†]			Continuous Operation			Minimum Brake Resistor Value (Ω)
				Brake Switch Current (A)	Brake Dissipation		Brake Switch Current (A)	Brake Dissipation		
		kW	hp		kW	hp		kW	hp	
D	7x0-4D0004...	1.1	1.5	1.5	1.1	1.5	1	0.75	1	520
	7x0-4D0006...	2.2	3	2.9	2.3	3	2	1.5	2	260
	7x0-4D0010...	4	5	5.9	4.5	-	3.9	3	-	130
	7x0-4D0012...	5.5	7.5	7.8	6	7.5	5.2	4	5	98
E	7x0-4E0016...	7.5	10	10.8	8.3	11.3	7.2	5.5	7.5	71
	7x0-4E0023...	11	15	14.7	11.3	15	9.8	7.5	10	52
F	7x0-4F0032...	15	20	21.5	16.5	22.5	14.4	11	15	35
	7x0-4F0038...	18.5	25	29.4	22.5	30	19.6	15	20	26
	7x0-4F0045...	22	30	36	27	37.5	24	18.5	25	21
G	7x0-4G0045...	22	30	36	27	37.5	24	18.5	25	21
	7x0-4G0060...	30	40	43	33	45	29	22	30	17.7
	7x0-4G0073...	37	50	59	45	60	39	30	40	13
H	7x0-4H0087...	45	60	73	55.5	75	49	37	50	10.5
	7x0-4H0105...	55	75	88	67.5	90	59	45	60	8.7
	7x0-4H0145...	75	100	108	82.5	113	72	55	75	7
J	7x0-4J0180...	90	125	147	113	150	98	75	100	5.2
	7x0-4J0205...	110	150	176	135	188	118	90	125	4.3
	7x0-4J0260...	132	200	216	165	225	144	110	150	3.55

[†] = 20s maximum, 30% duty

E-12 Technical Specifications - Power Stack

Appendix F: Technical Specifications - Control Module

ENVIRONMENTAL DETAILS

Operating Temperature	<p>Operating temperature is defined as the surrounding air temperature of the drive, when the drive and other equipment adjacent to it is operating at worst case conditions.</p> <p>NORMAL DUTY (ND): 0°C to 40°C, derate up to a maximum of 50°C HEAVY DUTY (HD): 0°C to 45°C, derate up to a maximum of 50°C</p> <p>Output power is derated linearly at 2% per degree centigrade for temperature exceeding the maximum rating for the drive.</p> <p>Maximum operating temperature of the AC30D and AC30A in the 24V dc supplied operating mode, without power applied to the stack, is 45°C.</p>
Storage Temperature	-25°C to +55°C
Shipping Temperature	-25°C to +70 °C
Product Enclosure Rating	IP20 – remainder of surfaces (Europe) UL (c-UL) Open Type (North America/Canada)
Altitude	If greater than 1000m above sea level, derate by 1% per 100m to a maximum of 2000m
Humidity	Maximum 85% relative humidity at 40°C non-condensing
Atmosphere	Non flammable, non corrosive and dust free
Climatic Conditions	Class 3k3, as defined by EN60721-3-3
Chemically Active Substances	<p>For the standard product (which inherently includes our optimal level of conformal coating) compliance with EN60721-3-3 is as follows –</p> <ul style="list-style-type: none"> a) Both classes 3C3 and 3C4 for hydrogen sulphide gas (H₂S) at a gas concentration of 25ppm for 1200 hours. b) Both classes 3C1 (rural) and 3C2 (urban) for all nine defined substances as defined in table 4. <p>Classes 3C1 and 3C2 are valid for both storage and transportation purposes.</p> <p>Note: Product was tested and validated with a hydrogen sulphide environment of 25ppm for a continuous period of 1200 hours and validated throughout the test period without failure.</p>
Vibration	<p>Test Fc of EN60068-2-6</p> <p>10Hz<=f<=57Hz sinusoidal 0.075mm amplitude 57Hz<=f<=150Hz sinusoidal 1g 10 sweep cycles per axis on each of three mutually perpendicular axis</p>

F-2 Technical Specifications - Control Module

SAFETY DETAILS

Overvoltage Category	Overvoltage Category II (230V TN) for User Relays
Pollution Degree	Pollution Degree II (non-conductive pollution, except for temporary condensation) for control electronics Pollution Degree III (dirty air rating) for through-panel mounted parts
North America/Canada	Complies with the requirements of UL508C as an open-type drive.

ANALOG INPUTS/OUTPUTS

ANIN 01 (X11/01), ANIN 02 (X11/02), ANOUT 01 (X11/03), ANOUT 02 (X11/04), conforming to EN61131-2

	Inputs	Output
Range	ANIN 01: Range selected by parameter 0001 from: 0 to 10V, -10V to +10V, 0 to 20mA, 4 to 20mA ANIN 02: Range selected by parameter 0002 from: 0 to 10V, -10V to +10V Absolute maximum input current 25mA in current mode (ANIN 01 only) Absolute maximum input voltage $\pm 24V$ dc in voltage mode	ANOUT 01: Range selected by parameter 0003 from: 0 to 10V, -10V to +10V ANOUT 02: Range selected by parameter 0004 from: 0 to 10V, 0 to 20mA, 4 to 20mA Maximum rated output current in voltage mode 10mA, with short circuit protection
Impedance	Input impedance: Voltage range = $22k\Omega$ Current range = 120R	Load impedance: Voltage range $\geq 1k\Omega$ Current range $\leq 600\Omega$
Resolution	12 bits (1 in 4096) over full range	11 bits (1 in 2048)
Accuracy	Better than $\pm 1\%$	Better than $\pm 1\%$
Sample / Update Rate	1ms	1ms

REFERENCE OUTPUTS

+10VREF (X11/05), -10VREF (X11/06)

Output Voltage	+10V and -10V
Accuracy	Better than $\pm 0.5\%$
Output Current	$\leq 10\text{mA}$
Overload / Short Circuit Protection	Indefinite

DIGITAL INPUTS

DIGIN 01 (X13/02) – DIGIN 03 (X13/04), DIG IN 04 (X12/01) – DIGIN 07 (X12/04), conforming to EN61131-2

Nominal Rated Voltage	24V												
Operating Range	DIGIN 01, DIGIN 02, DIGIN 03, DIGIN 04, DIGIN 05, DIGIN 06, DIGIN 07: 0-5V dc = OFF, 15-24V dc = ON (absolute maximum input voltage $\pm 30\text{V}$ dc) <div style="float: right; margin-top: 10px;"> <table style="border-collapse: collapse;"> <tr> <td style="border: none; padding-right: 5px;">24V</td> <td style="border: none;">┌</td> <td style="border: none; padding-left: 5px;">ON</td> </tr> <tr> <td style="border: none; padding-right: 5px;">15V</td> <td style="border: none;">├</td> <td style="border: none; padding-left: 5px;">undefined state</td> </tr> <tr> <td style="border: none; padding-right: 5px;">5V</td> <td style="border: none;">├</td> <td style="border: none; padding-left: 5px;">OFF</td> </tr> <tr> <td style="border: none; padding-right: 5px;">0V</td> <td style="border: none;">└</td> <td style="border: none; padding-left: 5px;"></td> </tr> </table> </div>	24V	┌	ON	15V	├	undefined state	5V	├	OFF	0V	└	
24V	┌	ON											
15V	├	undefined state											
5V	├	OFF											
0V	└												
Input Threshold	Typically 10V												
Input Impedance	3.3k Ω												
Input Current	7.3mA \pm 10% @ 24V												
Sample Interval	1ms												

DIGITAL OUTPUTS

DIGOUT 01 (X12/01) – DIGOUT 04 (X12/04), conforming to EN61131-2

Nominal Open Circuit Output Voltage	24V (minimum 21V)
Rated Output Current	140mA: The total current available is 140mA, either individually or as the sum of all digital outputs and User +24V Supply.
Overload / Short Circuit Protection	Indefinite

F-4 Technical Specifications - Control Module

USER 24V SUPPLY OUTPUT

User +24V Output (X12/05), 0V (X12/06)

Nominal Open Circuit Output Voltage	24V (minimum 21V)
Rated Output Current	140mA: The total current available is 140mA, either individually or as the sum of all digital outputs and User +24V Supply.

AUXILIARY 24V INPUT (AC30V & AC30P ONLY)

+24V AUX input (X13/05), 0V AUX input (X13/06)

Operating Voltage	24V \pm 10% This is an optional auxiliary power input. It will keep the control module, digital I/O, options and GKP powered when the main power is off. It will not power any analog I/O. AC30V: A separate non-earthed SELV supply is required for each drive on which these inputs are used. AC30P: A common non-earthed SELV supply can be used to power more than one control module, by connecting the positive supply to the terminal +24V AUX input (X13/05) on each drive and connecting the negative supply to the common system 0V star-point (to which each drives 0V terminal X12/06 and X13/01 are connected).
Current	0.5A minimum supply required, per control module The supply to these inputs should be suitably externally fused at 2A, at each individual drive, to protect the control module and supply wiring.

RELAY OUTPUTS (AC30V ONLY)

Relay 01 (X14/01 – X14/02), Relay 02 (X14/03 – X14/04)

These are volt-free relay contacts:

Maximum Voltage	250V ac or 30V dc Protection against inductive or capacitive loads must be provided externally.
Maximum Current	3A resistive load

Technical Specifications - Control Module F-5

SYSTEM AUXILIARY 24V INPUT (AC30D & AC30A ONLY)

+24V System Aux. Input (X30/05), 0V System Aux. Input (X30/06)

Operating Voltage	<p>24V \pm10%</p> <p>This is the system auxiliary power input. It is used to power the isolated encoder power supply output (X31/07-08 and X32/07-08) and the encoder transmit output (X33/01-06).</p> <p>It will also keep the entire control module (digital I/O, analog I/O, options and GKP) powered when the main stack power is off.</p> <p>A common non-earthed SELV supply can be used to power more than one control module, by bussing the supply to the +24V system aux. input terminal (X30/05) and to the 0V system aux. input terminal (X30/06), on each drive.</p>
Input Current	<p>1.5A minimum supply required, per control module.</p> <p>2.0A peak current on power-up, per control module.</p> <p>The supply to these inputs should be suitably externally fused at 2A, at each individual drive, to protect the control module and supply wiring.</p>
Input Capacitance	150uF nominal.

SYSTEM BOARD DIGITAL INPUTS (AC30D & AC30A ONLY)

SB DIGIN 01 (X30/01) – SB DIGIN 03 (X30/03), SB DIGIN 04 (X34/05) – SB DIGIN 06 (X34/07), conforming to EN61131-2

Nominal Rated Voltage	24V	
Operating Range	<p>SB DIGIN 01, SB DIGIN 02, SB DIGIN 03:</p> <p>0-5V dc = OFF, 15-24V dc = ON</p> <p>(absolute maximum input voltage \pm30V dc)</p>	<p>A vertical scale from 0V to 24V. A bracket from 0V to 5V is labeled 'OFF'. A bracket from 15V to 24V is labeled 'ON'. The region between 5V and 15V is shaded grey and labeled 'undefined state'.</p>
Input Threshold	Typically 10V	
Input Impedance	2.6k Ω	
Input Current	9.2mA \pm 10% @ 24V	
Sample Interval	1ms	

F-6 Technical Specifications - Control Module

SYSTEM BOARD DIGITAL OUTPUTS (AC30A ONLY)

SB DIGOUT 01 (X34/05) – SB DIGOUT 03 (X34/07), conforming to EN61131-2

Nominal Open Circuit Output Voltage	24V (minimum 19V)
Rated Output Current	100mA: The total current available is 100mA, either individually or as the sum of all digital outputs.
Overload / Short Circuit Protection	Short-circuit protected, though protection is combined with Encoder Transmit Outputs. Therefore, faults on SB Digital Outputs will also affect Encoder Transmit Outputs.

PULSE ENCODER POWER SUPPLY OUTPUT (AC30D ONLY)

Encoder PSU Output +ve (X31/07, X32/07), Encoder PSU Output 0V (X31/08, X32/08)

Output Voltage	Programmable: 5V, 12V, 15V or 20V
Rated Output Current	Limited to 500mA and 5W: 500mA @ 5V 417mA @ 12V 333mA @ 15V 250mA @ 20V
Isolation	Galvanic isolation from control 0V. Power supply output has two terminals for each connection, for ease of use in supplying two encoders (AC30D only).
Protection	Short-circuit protected.

SIN/COS ENCODER POWER SUPPLY OUTPUT (AC30A ONLY)

Encoder PSU Output +ve (X35/07), Encoder PSU Output 0V (X35/08)

Output Voltage	Programmable: 5V or 10V
Rated Output Current	Limited to 250mA and 1.25W: 250mA @ 5V 125mA @ 10V
Protection	Short-circuit protected.

Technical Specifications - Control Module F-7

PULSE ENCODER INPUTS (AC30D ONLY)

Encoder 1 A (X32/01), Encoder 1 /A (X32/02), Encoder 1 B (X32/03), Encoder 1 /B (X32/04), Encoder 1 Z (X32/05), Encoder 1 /Z (X32/06), Encoder 2 A (X31/01), Encoder 2 /A (X31/02), Encoder 2 B (X31/03), Encoder 2 /B (X31/04), Encoder 2 Z (X31/05), Encoder 2 /Z (X31/06)

Signalling Level	5V (TTL, RS422, RS485) to 24V (HTL).
Logic Threshold	Selectable: Low level – nominally 1.8V (suitable for 5V signaling). High level – nominally 6.5V.
Input Current	Typ. 7mA @ 24V input.
Absolute maximum input voltage	+/- 30V
Counting Modes	Selectable: Quadrature Clock + Direction (Clock on channel A, direction on channel B)
Maximum Count Frequency	250kHz pulse rate
Maximum Speed of Rotation	Minimum of 250kHz / no. of lines & 30000rpm
Quadrature Requirements	Duty cycle – 40% to 60% Displacement (A to B) – 90° +/- 45°
Isolation	Individually isolated A, B and Z input channels. Galvanic isolation.

F-8 Technical Specifications - Control Module

SIN/COS ENCODER INPUTS (AC30A ONLY)

Encoder SIN+ (X35/01), Encoder SIN- (X35/02), Encoder COS+ (X35/03), Encoder COS- (X35/04), Encoder Z (X35/05), Encoder /Z (X35/06)

Input Format	Differential, non-isolated.
Nominal input levels	1V peak-to-peak, differential.
Common-mode range	1V to 4V with respect to 0V.
Receiver input impedance	120Ω
Absolute maximum input voltage	+/- 30V
Counting Modes	Quadrature
Maximum Count Frequency	250kHz line rate
Maximum Speed of Rotation	Minimum of 250kHz / no. of lines & 30000rpm

RS485 ENDAT ENCODER INPUTS (AC30A ONLY)

RS485 Data+ (X34/01), RS485 Data- (X34/02), RS485 Clock+ (X34/03), RS485 Clock- (X34/04)

Input Format	Differential, non-isolated.
RS485 bidirectional channel (Data)	Nominal output / maximum input +5V with respect to Encoder PSU Output 0V (X35/08). Absolute maximum input +12V to -7V.
RS485 output channel (Clock)	Nominal output 0 to 5V with respect to Encoder PSU Output 0V (X35/08).

ENCODER TRANSMIT OUTPUTS (AC30D & AC30A ONLY)

Encoder Transmit A (X33/01), Encoder Transmit /A (X33/02), Encoder Transmit B (X33/03), Encoder Transmit /B (X33/04), Encoder Transmit Z (X33/05), Encoder Transmit /Z (X33/06)

Signalling Type	Differential: A to /A, B to /B and Z to /Z
Output Voltage Levels	Selectable: Off-load nominal output (differential) voltages: 5V, 12V, 15V or 20V Rated-load nominal output (differential) voltages: 4.0V, 10.8V, 13.9V or 18.9V (respectively)
Rated Output Current	33mA (100mA total for all three outputs combined)
Maximum Count Frequency	250kHz pulse rate
Resolution of Output Period	7ns (0.18% @ 250kHz)
Operating Modes	Selectable: Repeat of Encoder Input 1 Repeat of Encoder Input 2 Synthetic encoder output Digital outputs (general purpose)
Propagation Delay in Repeat Mode	< 1µs
Protection	Short-circuit protected, though protection is combined with SB Digital Outputs. Therefore, faults on encoder transmit outputs will also affect SB Digital Outputs.

F-10 Technical Specifications - Control Module

Parker Worldwide

Europe, Middle East, Africa

AE – United Arab Emirates,
Dubai
Tel: +971 4 8127100
parker.me@parker.com

AT – Austria, Wiener Neustadt
Tel: +43 (0)2622 23501-0
parker.austria@parker.com

AT – Eastern Europe, Wiener
Neustadt
Tel: +43 (0)2622 23501 900
parker.easteurope@parker.com

AZ – Azerbaijan, Baku
Tel: +994 50 2233 458
parker.azerbaijan@parker.com

BE/LU – Belgium, Nivelles
Tel: +32 (0)67 280 900
parker.belgium@parker.com

BG – Bulgaria, Sofia
Tel: +359 2 980 1344
parker.bulgaria@parker.com

BY – Belarus, Minsk
Tel: +48 (0)22 573 24 00
parker.poland@parker.com

CH – Switzerland, Etoy
Tel: +41 (0)21 821 87 00
parker.switzerland@parker.com

CZ – Czech Republic, Klecany
Tel: +420 284 083 111
parker.czechrepublic@parker.com

DE – Germany, Kaarst
Tel: +49 (0)2131 4016 0
parker.germany@parker.com

DK – Denmark, Ballerup
Tel: +45 43 56 04 00
parker.denmark@parker.com

ES – Spain, Madrid
Tel: +34 902 330 001
parker.spain@parker.com

FI – Finland, Vantaa
Tel: +358 (0)20 753 2500
parker.finland@parker.com

FR – France, Contamine s/Arve
Tel: +33 (0)4 50 25 80 25
parker.france@parker.com

GR – Greece, Athens
Tel: +30 210 933 6450
parker.greece@parker.com

HU – Hungary, Budaörs
Tel: +36 23 885 470
parker.hungary@parker.com

IE – Ireland, Dublin
Tel: +353 (0)1 466 6370
parker.ireland@parker.com

IL – Israel
Tel: +39 02 45 19 21
parker.israel@parker.com

IT – Italy, Corsico (MI)
Tel: +39 02 45 19 21
parker.italy@parker.com

KZ – Kazakhstan, Almaty
Tel: +7 7273 561 000
parker.easteurope@parker.com

NL – The Netherlands, Oldenzaal
Tel: +31 (0)541 585 000
parker.nl@parker.com

NO – Norway, Asker
Tel: +47 66 75 34 00
parker.norway@parker.com

PL – Poland, Warsaw
Tel: +48 (0)22 573 24 00
parker.poland@parker.com

PT – Portugal
Tel: +351 22 999 7360
parker.portugal@parker.com

RO – Romania, Bucharest
Tel: +40 21 252 1382
parker.romania@parker.com

RU – Russia, Moscow
Tel: +7 495 645-2156
parker.russia@parker.com

SE – Sweden, Spånga
Tel: +46 (0)8 59 79 50 00
parker.sweden@parker.com

SK – Slovakia, Banská Bystrica
Tel: +421 484 162 252
parker.slovakia@parker.com

SL – Slovenia, Novo Mesto
Tel: +386 7 337 6650
parker.slovenia@parker.com

TR – Turkey, Istanbul
Tel: +90 216 4997081
parker.turkey@parker.com

UA – Ukraine, Kiev
Tel: +48 (0)22 573 24 00
parker.poland@parker.com

UK – United Kingdom, Warwick
Tel: +44 (0)1926 317 878
parker.uk@parker.com

ZA – South Africa, Kempton Park
Tel: +27 (0)11 961 0700
parker.southafrica@parker.com

North America

CA – Canada, Milton, Ontario
Tel: +1 905 693 3000

US – USA, Cleveland
Tel: +1 216 896 3000

Asia Pacific

AU – Australia, Castle Hill
Tel: +61 (0)2-9634 7777

CN – China, Shanghai
Tel: +86 21 2899 5000

HK – Hong Kong
Tel: +852 2428 8008

IN – India, Mumbai
Tel: +91 22 6513 7081-85

JP – Japan, Tokyo
Tel: +81 (0)3 6408 3901

KR – South Korea, Seoul
Tel: +82 2 559 0400

MY – Malaysia, Shah Alam
Tel: +60 3 7849 0800

NZ – New Zealand, Mt Wellington
Tel: +64 9 574 1744

SG – Singapore
Tel: +65 6887 6300

TH – Thailand, Bangkok
Tel: +662 186 7000

TW – Taiwan, Taipei
Tel: +886 2 2298 8987

South America

AR – Argentina, Buenos Aires
Tel: +54 3327 44 4129

BR – Brazil, Sao Jose dos Campos
Tel: +55 800 727 5374

CL – Chile, Santiago
Tel: +56 2 623 1216

MX – Mexico, Toluca
Tel: +52 72 2275 4200

European Product Information Centre
Free phone: 00 800 27 27 5374
(from AT, BE, CH, CZ, DE, DK, EE, ES, FI,
FR, IE, IL, IS, IT, LU, MT, NL, NO, PL, PT, RU,
SE, SK, UK, ZA)



Parker Hannifin Manufacturing Limited
Automation Group, Electromechanical & Drives Division Europe,
New Courtwick Lane,
Littlehampton, West Sussex. BN17 7RZ
Office: +44 (0)1903 737000
Fax: +44 (0)1903 737100
www.parker.com/eme